



Wells-next-the-Sea

Design Guidance and Codes

FINAL REPORT

June 2023

Quality information

Document name	Ref	Prepared for	Prepared by	Date	Reviewed by
Wells-next-the-Sea Design Guidance and Codes	v1	Wells-next-the-Sea Town Council	AECOM	210813	Wells-next-the-Sea Neighbourhood Plan Working Party
Wells-next-the-Sea Design Guidance and Codes	v2	Wells-next-the-Sea Town Council	AECOM	220121	Wells-next-the-Sea Neighbourhood Plan Working Party

Revision history

Revision	Revision date	Details	Name	Position
5	230615	Final	Ben Castell	Director
4	220228	Review	Ben Castell	Director
3	220121	Review	Roger Arguile Cheryl Curtis Lyndsay Dew John Edwards David Fennell Nichola Holmes Rachel Leggett Peter Rainsford	Wells-next-the-Sea Neighbourhood Plan Working Party
2	210728	Review	Ben Castell	Director
1	210726	Research, review	Graziano Di Gregorio	Senior Urban Designer
0	210721	Research, drawings	Stela Kontogianni	Urban Designer

This document has been prepared by AECOM Limited for the sole use of our client (the "Client") and in accordance with generally accepted consultancy principles, the budget for fees and the terms of reference agreed between AECOM Limited and the Client. Any information provided by third parties and referred to herein has not been checked or verified by AECOM Limited, unless otherwise expressly stated in the document. No third party may rely upon this document without the prior and express written agreement of AECOM Limited.

Contents

1. Introduction	5
2. Context analysis	10
3. Design guidance and codes	40
4. Checklists	88
5. Delivery	96



01

Introduction

1. Introduction

1.1. Introduction

Through the Government's Neighbourhood Planning Programme led by Locality, AECOM has been commissioned to provide design support to Wells-next-the-Sea Neighbourhood Plan Working Party.

This document is intended to support Neighbourhood Plan policies that guide the assessment of future development proposals and encourage high quality design. It advises on physical development helping to create distinctive places integrated with the town and the natural environment.

1.2. Objectives

The main objective of this report is to provide bespoke design guidance and codes that future developments within the Neighbourhood Area must follow in order to respond to the special character of the parish.

1.3. Process

Following an inception meeting, AECOM and the members of the Neighbourhood Plan Working Party carried out a high-level assessment of the town. The following steps were agreed with the group to produce this report:

- Initial meeting to discuss brief between AECOM and Wells-next-the-Sea Neighbourhood Plan Working Party. As this was during the national COVID 19 lockdown, a joint virtual site visit was carried out via Microsoft Teams;
- Analysis of the area including a site visit;
- Review of relevant policy and previous documents;
- Preparation of design guidance and codes to be used to assess future development;
- Draft report issued for comment; and
- Final report.

1.4. The area of study

The parish of Wells-next-the-Sea is located in North Norfolk on the coast. It has an area of 16.31 sq km and a population of 2,165 at the 2011 census.

It is located approximately 16 km north of Fakenham, 24 km to the east of Hunstanton and 32 km to the west of Cromer. In addition, Norwich lies 51 km to the south-east.

In the past, the town was served by a railway station and it was connected to the British Rail network by two lines.

However, in the 1960's both lines ceased to operate. Today, the closest railway station is in King's Lynn (approximately 40 km distance).

There is a range of retail, commerce, and health facilities, and a well-developed tourism infrastructure, including accommodation and the beach. The town has two schools: Wells-next-the-Sea Primary and Nursery School and Alderman Peel High School. There are five places of active religious worship in the town, serving the Anglican, Catholic, Congregational, Methodist and Quaker residents of the parish and beyond.



Figure 1: Map showing the location of Wells-next-the-Sea.



Figure 2: Wells-next-the-Sea in a context.

- KEY
- Parish boundary & Neighbourhood Area
 - Water bodies
 - A-roads
 - B-roads
 - Main local roads

1.5. Key reference policy documents

The following documents have informed this Design Guidance and Codes document.

Any new development application should be familiar with these documents and where relevant make explicit reference to how each of them is taken into account in the proposal.

National design guidance

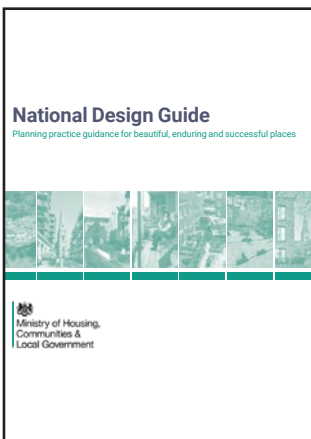

National Design Guide

Ministry of Housing, Communities & Local Government, 2019

The National Design Guide (NDG) makes clear that creating high quality buildings and places is fundamental to what the planning and development process should achieve.

The NDG should be read in conjunction with the design codes in this document to achieve the best possible development.

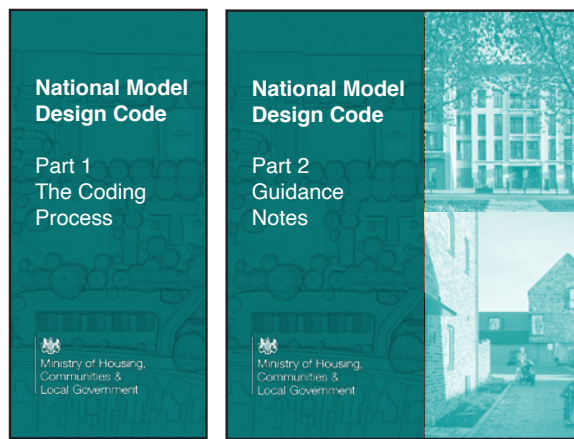

National Model Design Code

Ministry of Housing, Communities & Local Government, 2021

The purpose of the National Model Design Code is to provide detailed guidance on the production of design codes, guides and policies to promote successful design. It expands on the ten characteristics of good design set out in the National Design Guide, which reflects the government's priorities and provides a common overarching framework for design.

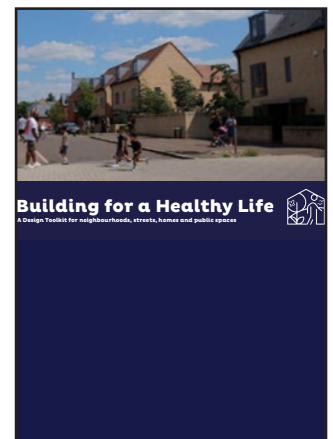

Building for a Healthy Life

Homes England, 2020

Building for a Healthy Life (BHL) updates England's most widely known and used design tool for creating places that are better for people and nature. The original 12 point structure and underlying principles within Building for Life 12 are at the heart of BHL.

District design guidance

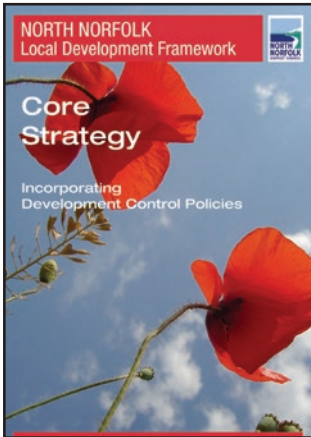

North Norfolk Local Development Framework, Core Strategy

North Norfolk District Council, 2008

This document sets out the Core Strategy for the whole district as well as strategic policies for settlements including Wells-next-the-Sea.

A new North Norfolk Local Plan, covering the period up to 2036, is being prepared.



North Norfolk Strategic Flood Risk Assessment

North Norfolk District Council, 2017

This document forms part of the evidence base of the Local Plan and Sustainability Appraisal providing information about flooding risks.

Design codes and future development need to take this constraint into account to achieve the best possible result.



North Norfolk Landscape Character Assessment

North Norfolk District Council, 2021

The purpose of this document is to provide information about the existing landscape characters, dark skies, and tranquility zones.

This information will inform the context for policies and future design proposals.

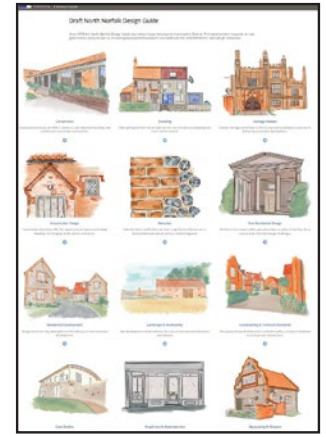

North Norfolk Design Guide

North Norfolk District Council

Since 1974 the North Norfolk Design Guide¹ has helped shape development across the District.

This latest version responds to new government policy as well as increasing development pressure and continues the commitment to raise design standards.

¹ Found [here](#).



02

Context analysis

2. Context analysis

2.1. Introduction

This section outlines the broad physical, historical and contextual characteristics of Wells-next-the-Sea. It analyses the parish's settlement pattern, heritage, landscape and mobility and sets out the key features of each component.

2.2. Settlement pattern and urban form

The town has been a fishing port and a seaport since before the 14th century and it was considered a significant port in the past with many ships operating there. The town was also known for the production of malt contributing to a great amount of exports from the country.

The historic town centre was developed along Polka Road and westwards as well as along the Quay. Many improvements took place in 1845 as part of attempts to improve the town. The railway came in 1857 reducing the harbour trade which was then revived after World War 2. This revival transformed the Quay into a busy place from the 1960s to 1990s. In the nineteenth century, malt production grew in scale and became more industrial. Reduced demand in the 1920s led to the overnight closure of Wells Maltings followed by a period of industrial decline in the town.

Later expansions of the town shaped today's settlement pattern. In particular, the areas to the south, west and east of the historic core were developed in the 19th and 20th century, whilst there are also examples of recent infill developments within the urban fabric. In addition, a recent development scheme, added south of the old railway line and east of B1105, forms the latest large-scale addition to the existing settlement.

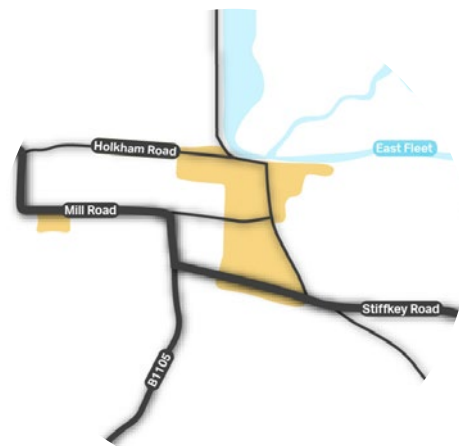

Figure 3: Wells-next-the-Sea settlement boundary in the late 18th century.



Figure 4: Wells-next-the-Sea settlement boundary in approximately 1967.

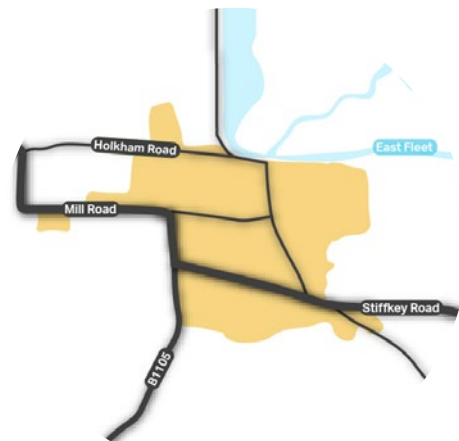

Figure 5: Wells-next-the-Sea settlement boundary today.

2.3. Mobility

The main road A149, which cuts through the town in the east-west direction, and the southern approach B1105 are the main routes that connect the town to the surrounding strategic road network and towns and villages.

The residential neighbourhoods and the mixed-use parts of the town have good connectivity, being served by mainly connected street networks, whilst there are limited examples of cul-de-sac streets.

The town also benefits from a network of Public Rights of Way connecting the settlement to the surrounding countryside and the coast.

In addition, there is a cycle route (National Cycle Route 1), running north along the coastal path and south along Warham Road and other local roads and green lanes to the south.

- KEY
- Parish boundary & Neighbourhood Area
 - Water bodies
 - Road networks
 - Footpaths
 - Bridleways
 - Coastal path
 - National Cycle Route 1

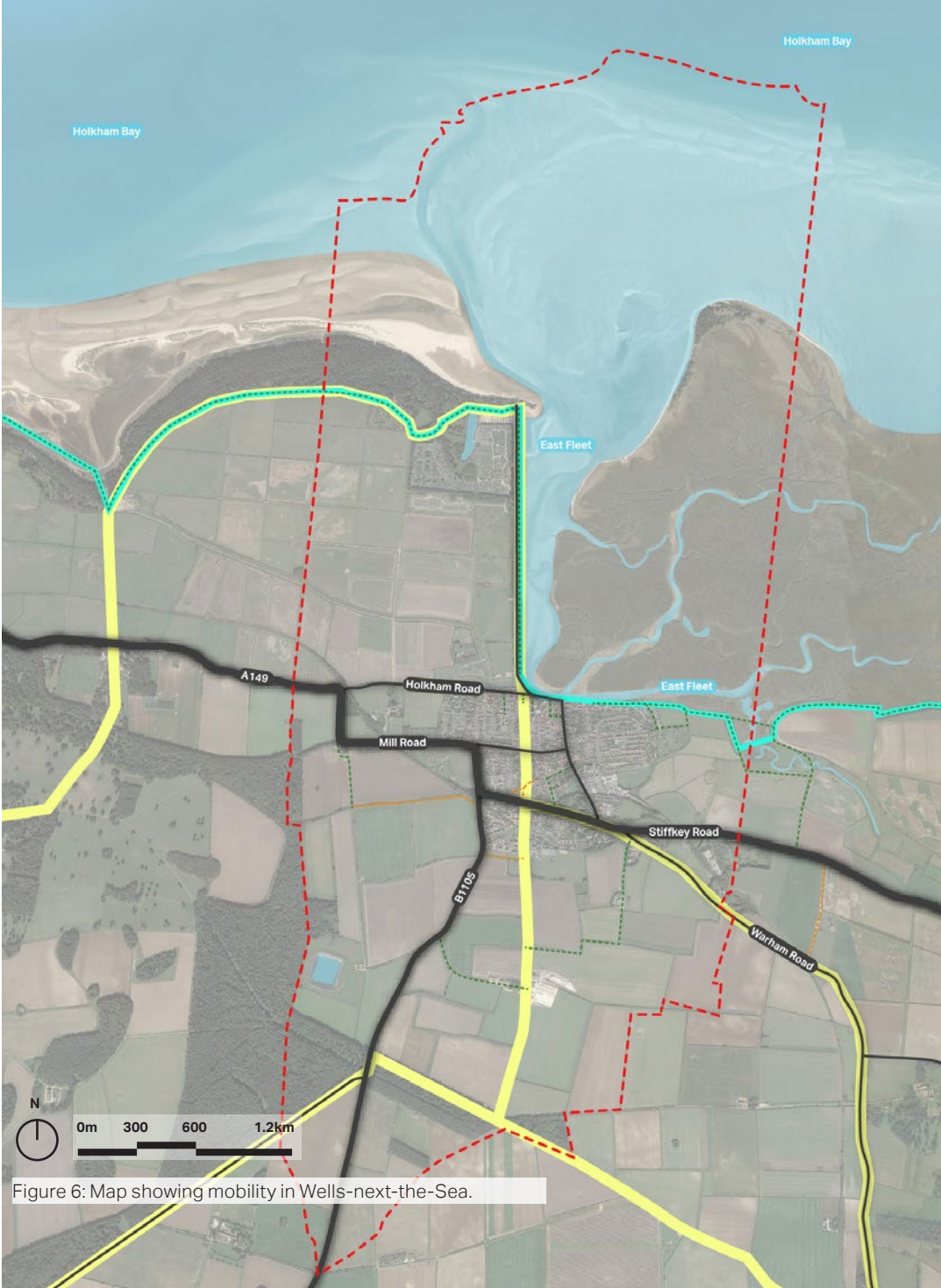

Figure 6: Map showing mobility in Wells-next-the-Sea.

2.4. Heritage

The parish has a rich history which goes back to the 14th century. There is an extensive conservation area which includes the historic core of Wells-next-the-Sea.

There are many listed buildings within the parish (185) mainly located within the conservation area. Some distinctive examples that also act as local landmarks for the area are the Church of St Nicholas, the Normans, the Library and the Congregational Church.

2.5. Environment and landscape

The entire parish is designated an Area of Outstanding Natural Beauty. There are Priority Habitat Inventories along the coast and the old railway line, Ramsar Sites, Special Areas of Conservation and Sites of Special Scientific Interest to the north of the Parish. In addition, there is a designation for Registered Parks and Gardens at Holkham Hall to the southwest of the parish boundary. All these land-based designations will need to be taken into account in future developments.

- KEY**
- Parish boundary & Neighbourhood Area
 - Water bodies
 - Priority habitat inventory
 - Conservation area
 - Registered parks & gardens
 - AONB
 - Ramsar sites, Special Areas of Conservation & Site of Special Scientific Interest
 - Road networks

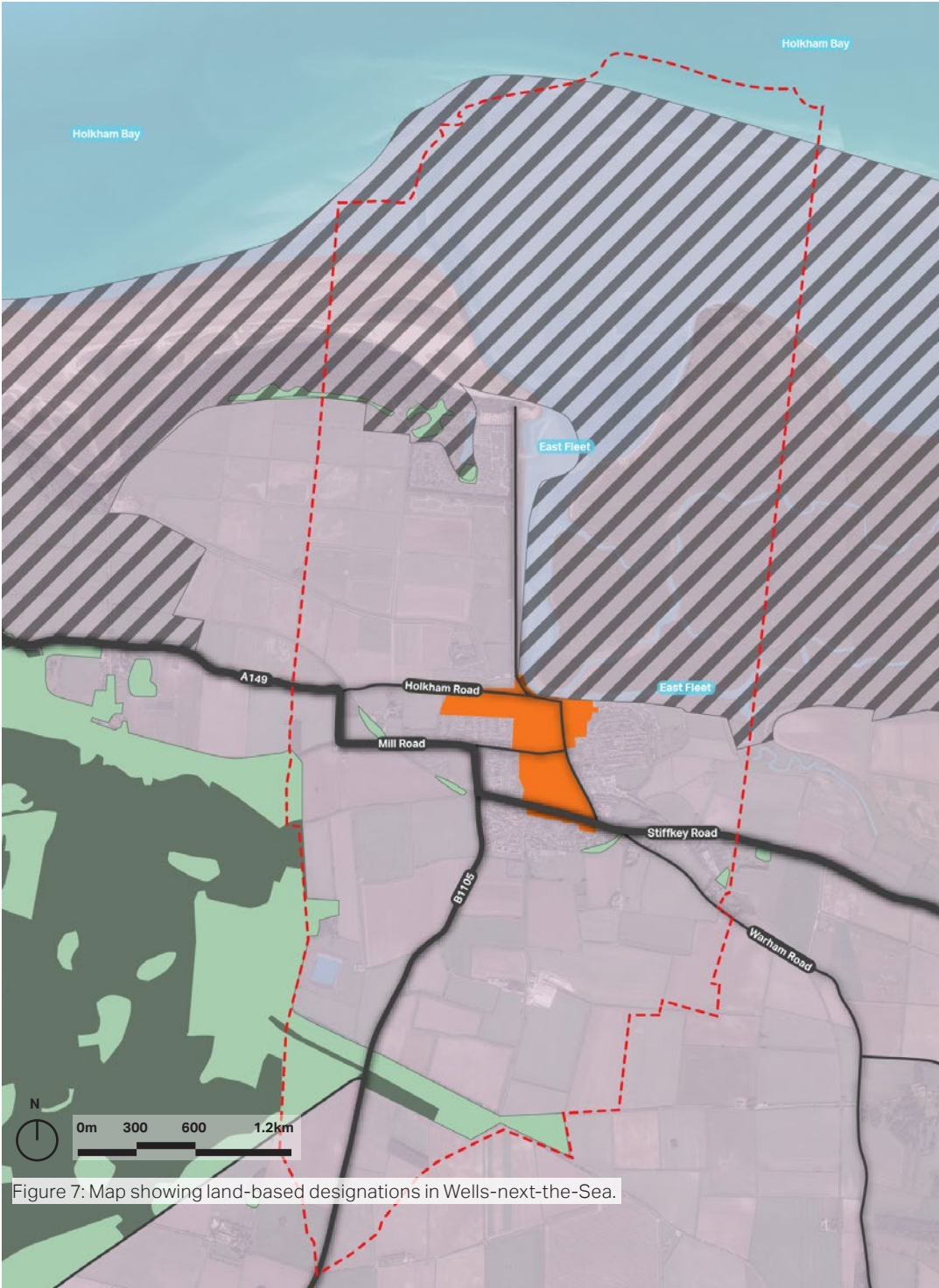

Figure 7: Map showing land-based designations in Wells-next-the-Sea.

2.6. Character areas

Wells-next-the-Sea Neighbourhood Plan Working Party identified seven character areas within the town. These are:

Character area 1 - Town core;

Character area 2 - West Central area;

Character area 3 - East area;

Character area 4 - South area;

Character area 5 - West area;

Character area 6 - Southwest area;

Character area 7 - Southeast area; and

Character area 8 - Beach area.

The next pages will present the character appraisal of the above character areas conducted by the Wells-next-the-Sea Neighbourhood Plan Working Party. The appraisal will include a description of land uses, layout, roads, streets and routes, topography, spaces, buildings, landmarks, green and natural features, streetscape and views.

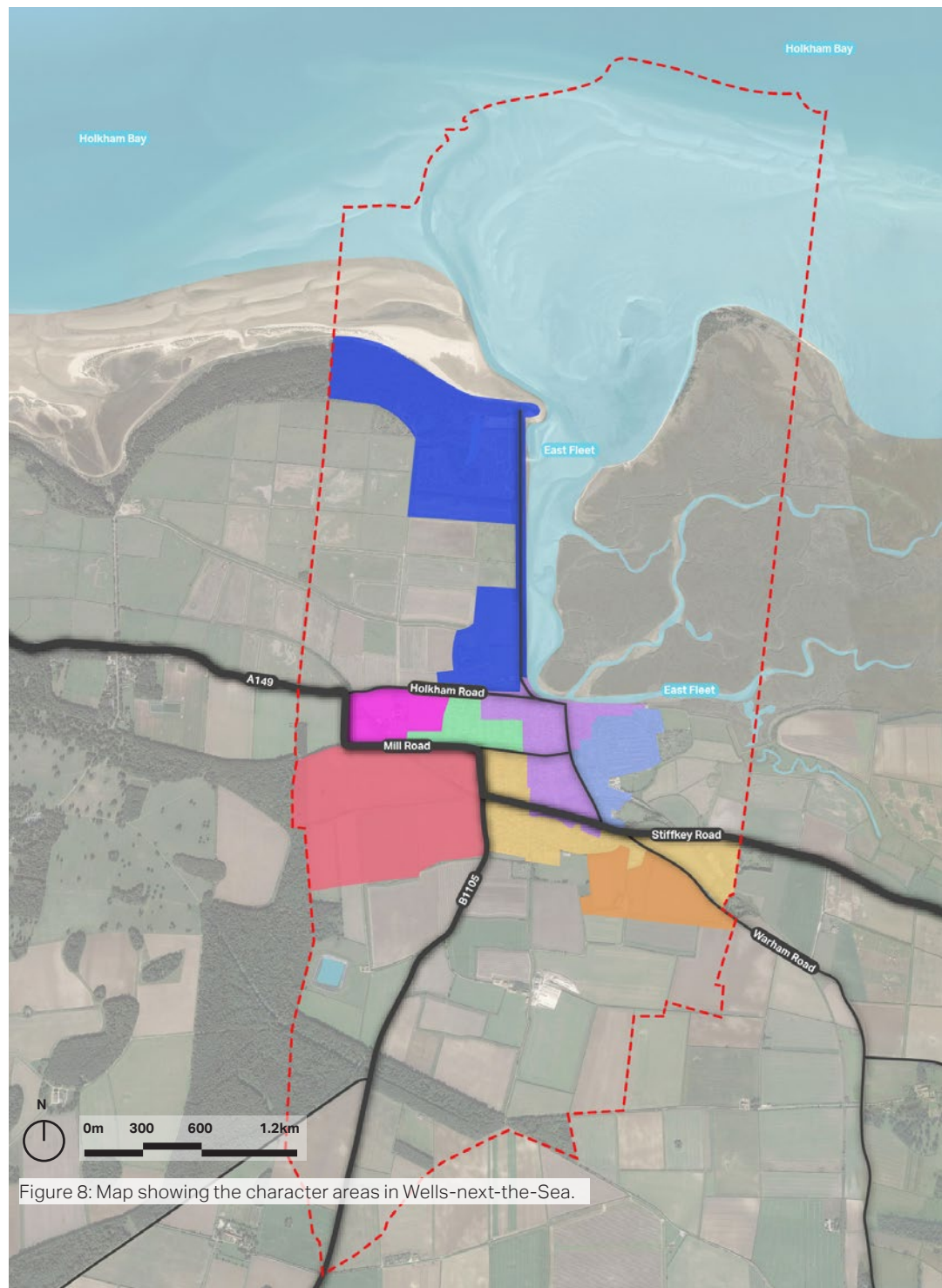

Figure 8: Map showing the character areas in Wells-next-the-Sea.



Figure 9: Map showing the location of character area 1.

Character area 1: Town core; The old centre of the town

LAND USES

- The area can be divided into the area to the north of Station Road which lies at the top of the long ridge running east west through the town and that which lies to the south as far as both sides of Church Street.
- The northern section consists mostly of yards which run north-south which were once either cottages or industrial buildings.
- The grid pattern of the town is visible with the pantile roof ridges aligning mainly north/south.
- Many terraces of cottages have access across shared yards with homes on the one side and original sculleries, toilets and washrooms on the other (mostly now replaced with provision within the houses).
- The land between Standard Road and the Glebe was until 1929 almost entirely industrial (Croft Yard, Staithe Street, Sun Yard, Jicklings Yard, Red Lion Yard, Tunns Yard, Knotts Yard and the Glebe). The maltings were eventually, post 1972, replaced by houses. The Yards lack frontages.
- Moving west a series of yards (Lugger Yard, Stearmans Yard, Blackhorse Yard, Mindhams Yard, Chapel Yard and Dogger Lane) remain for the most part residential though largely taken by second homeowners and holiday lets.
- The land between Lugger Yard and Stearmans Yard has been cleared and is now a car park and the surrounds of a demolished public house (Ark Royal).
- Freeman Street consists of a series of cottages of different ages at the foot of the long slope up to Theatre Road, some of considerable age -seventeenth century in the case of Brigg Square- and possibly earlier. Those to the north were built by John Freeman in the 1820s.
- At the top of the easterly yards, Theatre Road contains the Wells Memorial Institute Club, opened in 1933, some Victorian villas and, to the west, a nineteenth century Methodist chapel and a modern housing association development beyond, comprising modern terraced houses.
- Staithe Street is a shopping street whose premises abut directly onto the highway. It includes a large former malting which is a community leisure facility. It also includes an eighteenth-century town house (Mayshiel) massively altered in the nineteenth century whose former garden has been given over to a modern parade of shops.
- Several pedestrian pathways (Shop Lane, Anchor Lane, Gambles Yard) lead both east and west from Staithe Street.
- Inland to the east of Staithe Street industrial dwellings have been either converted or replaced by small closes of houses (Stratton Place, Ramm's Court) off Shop Lane, a former access roadway to several now demolished maltings.
- To the south the continuation of Croft Yard southwards, Bolts Close is flanked by flint and brick walls behind which are cottages of various ages, and the former telephone exchange leading to Station Road.
- Station Road runs along the east-west ridge from the Buttlands and includes an eighteenth-century Congregational chapel, a late Victorian public house, a small number of shops, the post office, the library and the modern health centre. The former Railway Hotel (latterly Lifeboat Inn) closed in 2020.
- The land to the east of the bottom of Standard Road, along the waterside consists initially of pre-twentieth century dwellings, some of considerable merit (the Standard Chandlery and the Old Custom House) two yards (Wounded Heart Yard, Jolly Sailors Yard) east of which are a series of mostly twentieth century dwellings and, at the end of the metalled road, former whelk houses and other industrial properties.

Character area 1: Town core; The old centre of the town

<p>LAND USES</p>	<ul style="list-style-type: none"> - Uphill on the eastern side of Standard Road stands a former coaching inn (Standard Chandlery), several eighteenth-century brick buildings and a grand house (the Normans) which still remains, which still remains but whose gardens has been filled with a close of modern town houses. - On the west side of Standard Road, several older cottages are succeeded by a set-back hardware shop, an old former whelk factory whose walls have been pierced by windows and an entrance door. A long flint wall leads to the beginning of Shop Lane, which then turns to modern brick and flint houses and a small close of older houses. - To the west of Staithe Street and south of Jicklings and Red Lion yards, post-war developments between Newgates Lane and Clubbs Lane are more mixed but include flats, both newly built and conversions and the service entrances to shops on Staithe Street including an abattoir. - South of the east-west road (Station Road) is a large green owned by Wells Town Council called the Buttlands which is fringed by lime trees and Georgian town houses. - To the east of the Buttlands, is the old shopping street called High Street (none of whose shops remain) running largely south and which again lacks frontage areas running down to the church. Many, though not all of the shop fronts remain. At the top of the Street is the former bank now being given over to a dentists' surgery. - A narrow pedestrian alleyway halfway down the High Street leads past the old school connecting High Street with Polka Road. A small open yard is partly surrounded by former fishermen's cottages and a substantial former school building (Barn Close House). - Several narrow lanes (Green Dragon Lane/Chancery Lane) lead from High Street westwards to the Buttlands. - At the bottom of High Street (Church Plain) there is a mix of Tudor alms houses, Victorian street houses (including the former Police Station and House) and late twentieth century replacement houses all fronting onto the street. The former Church Rooms are now a youth hostel. - A connecting road runs from Church Plain to Polka Road (Marsh Lane). Marsh House, an eighteenth century town house, lies to the north; to the south are several converted former agricultural buildings and their lairage (Church or Ramm's Marsh). - To the west of the arterial road (Polka Road) running downhill lies the 1838 schoolroom (now social housing) part of the garden of an eighteenth century house, a paddock (Church Marsh), the old cemetery and a modern close of housing. A number of modern closes have been built on former gardens (Beldorma Close, Shrublands). (See also the East Area). - To the south of the arterial road running east-west (A149) is the old road south (Market Lane) running uphill to the new cemetery; and now providing access to modern residential properties, a small private estate, a larger estate of bungalows to the east and the secondary school. (See South Area).
<p>LAYOUT</p>	<ul style="list-style-type: none"> - The whole area is quite tightly packed apart from the green space (the Buttlands), the paddock (Church Marsh) and the cemetery. Twentieth century infilling has reduced the size of many gardens.
<p>ROADS, STREETS, ROUTES</p>	<ul style="list-style-type: none"> - A major arterial road runs along the Quay turning south east (Standard Road/Polka Road) to the eastern edge of the town. - The Glebe, running south from the western edge of the Quay provides a route south via Theatre Road and Park Road onto the roads south and west. - The main A149 road runs east-west on the southern edge of the town (Church Street/Burnt Street) turning north to follow the coast road to Holkham and beyond. It has several pinch points which limit traffic flow. It joins the 'dry road' running south to Fakenham (B1105). - Several pedestrian pathways. - There are no cycle paths in the area.

Character area 1: Town core; The old centre of the town

TOPOGRAPHY	<ul style="list-style-type: none"> - An east-west ridge divides the town (as above) from that which faces the sea and the marshes, and the southerly part of the town which runs down to the major arterial road (A149), Burnt Street and Church Street. The A149 itself is on rising land as it proceeds eastwards towards the junction with Polka Road and the edge of the town.
SPACES	<ul style="list-style-type: none"> - As above the Buttlands is an open space fringed by lime trees surrounded by Georgian and Victorian town houses. - The old cemetery lies to the east of the church; the new cemetery lies to the south of the town at the end of Market Lane (as above). - Church Marsh, privately owned and also known as Ramm's Marsh, lies at the lowest point between Polka Road and the backs of the houses along High Street. It is used as a paddock for horses and alpacas. - Tugboat Yard is a small designated green space, with a village green opposite the Standard Chandlery and consists of north facing benches looking across the channel to the marshes.
BUILDINGS	<ul style="list-style-type: none"> - On the Quay is the largest building in the town, the Granary (1904-5). Two buildings of more than two storeys stand on either side of it. Other buildings are of two storeys only, some of them converted from industrial uses, with the exception of the frontage of the former Pauls' malting at the west end of the Quay. Another former malting stands at the beginning of the west side of Beach Road; it is an amusement arcade. - Most buildings in the town centre are two storey cottages (High Street, Freeman Street, the many yards as above). - Inland the Staithe Street malting and a block of flats at the top of Jicklings Yard (Malthouse Place) built in the 1980s are more than two stories high. - All other buildings are two storeys or lower. - Most properties are contiguous, consisting of terraces or continuous runs of houses. - The cottages are built almost universally of brick, with slate roofs in many cases cement-rendered and painted, and in some cases simply painted (e.g. High Street). - Pantiles have been widely used not only on a number of larger buildings (Crown Public House, Golden Fleece) but also on many houses on High Street and elsewhere. Some modern developments have made use of this style. Black glazed pantiles have been used on some "higher status" buildings in place of the more common unglazed orange clay pantiles. - Flint has been used, often mixed with re-used bricks on some buildings (e.g. Wounded Heart Yard, Brigg Square on Freeman Street); cottages were built in part or wholly with flint e.g. some former and current industrial buildings and a number of boundary walls (Standard Road west side, Newgates Lane on both sides, south side of Station Road east end). Because flint is unstable when being built, flint walls often have brick dividers at regular intervals. - Flint has also been used on several recent houses (Polka Place/Standard Road), the Maltings extension and very occasionally of carrstone, a local ironstone (the post office). - The age of houses varies massively from sixteenth century alms houses (Church Plain) to eighteenth century large houses (the Normans, Mayshiel, Newgates House, Manor House, Bishop Ingle House, Blenheim House, Marsh House) to twentieth century blocks of flats and houses. - Windows, often of sash type, have in many cases been replaced by UPVC. Hinged openings are rarer.

Character area 1: Town core; The old centre of the town

LANDMARKS	<ul style="list-style-type: none"> - The Granary (above) is instantly recognisable with its distinctive overhead gantry over the road on the Quay. - The church, which was rebuilt in 1883 after a fire, stands at the bottom of the church plain and is surrounded by a cleared churchyard, to east of which lies the old cemetery. - The old lifeboat house (Harbour Office) and the Eliza Adams memorial on the Quay. - The Quay with its curving granite stone structure.
GREEN & NATURAL FEATURES	<ul style="list-style-type: none"> - Beyond the designated area lie the channel, creeks and marshes. Church Marsh (Ramm's Marsh) is to the north of the old cemetery. There is pedestrian access from the church plain eastwards to Polka Road. - The coastal path eastwards from the whelk sheds follows the top of the flood defence bank with marshes and the sea to the north and open farmland and wetlands to the south.
STREETScape	<ul style="list-style-type: none"> - The area mostly lacks pavements (other than Standard Road/Polka Road), the streets being metalled. - There are finger signs pointing to significant features.
VIEWS	<ul style="list-style-type: none"> - The view down Staithe Street of the harbour channel. - The view down Standard Road of the marshes and creeks. - The view from Theatre Road over the channel and marshes. - The view southwards down High Street of the houses and the fields beyond. - The view from Tugboat Yard on the east quay across the marshes. - The view from Mill Road across the marshes. - The view from Warham Road to the marshes.



Figure 10: Character area 1.



Figure 11: Map showing the location of character area 2.

Character area 2: West Central area; Land to the west of Wells Town Core	
LAND USES	<ul style="list-style-type: none"> - Mainly residential. Currently, almost half of this area is a harmonious mixture of originally local authority properties, some now privately or housing association owned. - The remainder are approximately 40% private residential, 60% second homes or holiday accommodation. Dorrington House on Mill Road is a purpose-built residential home. Listed Arch House is now a B&B. - Most of the permanent residents have longstanding associations with Wells. - No retail outlets. - Recreational land in one block: Tennis courts, Wells Town and Elsmith Bowls Clubs plus croquet lawn, not currently in regular use but recently refurbished.
LAYOUT	<ul style="list-style-type: none"> - The local authority built properties (Park Road east side/Westfield Avenue) are laid out in linear, regular style, with long back gardens and a consistent building line. Parking is located in the frontages or on the road. - Many of the older private properties are built cheek by jowl, plus infill development, mostly with off street parking. - The exception is 1970s Russell Close cul-de-sac with ample driveways and garages and a more open, curved layout. - Bakers and Mainsail Yards, built in the early 2000s on the old petrol station site at the western end of Freeman St., are each arranged in a ring and are much taller than the adjacent cottages, although in keeping with the height of buildings on rising ground southwards. There is a four-storey turreted building on the west corner of the development. These yards were designed with garages on the ground floor as a flood protection measure but many of the garages have since been converted to furnished living spaces.
ROADS, STREETS, ROUTES	<ul style="list-style-type: none"> - Mill Road, Park Road and Theatre Road are two-way main routes through the town. These last 2 have little or no pavement. - Dogger Lane is a steep single track tarmac road. - The Gales Court/Road area has 5 access routes (1 unmade road and 2 pedestrian only paths). - Bases Lane leads to Mill Farm fields and recreation space, with a footpath to the Holkham Road and then to the Drift for beach access. - Bus routes along Mill Road and Freeman St/Holkham Road.
TOPOGRAPHY	<ul style="list-style-type: none"> - The Mill Road ridge divides the northern seaward side of this area from the southern inland-facing slope. - Bakers and Mainsail Yards and the north side of Freeman Street are in the flood zone. Properties on the south side of Freeman Street are set back and are on higher ground.

Character area 2: West Central area; Land to the west of Wells Town Core

SPACES	<ul style="list-style-type: none"> - The western side of this area gives onto grassed fields, a small football field and the Mill Road allotments. - The triangle of land (c.19 hectares) bounded by Mill Road, Two Furlong Hill and the old railway cutting has recently come back into the ownership of WTC. It is subject to a Holkham Estate covenant. It is used for paddocks and allotment gardens and designated as a Green Space in the NNDC Local Plan. The site has been put forward by WTC in the NP Call for Sites, excluding the allotments. If a residential development on part of the site was proposed, it would be desirable - There are no car parks. Mill Road and Clubbs Lane become congested during holiday periods when visitors also use these areas.
BUILDINGS	<ul style="list-style-type: none"> - Westfield Avenue/Gales Road are interwar grey brick, (some rendered) and tiled, 2 storey terraces or semi-detached. Eastern Mill Road are 1920s arts & crafts style redbrick rendered and tiled terraces or semi-detached. Gales Court consists of 1960s brick and tiled bungalows with some cladding and large square windows. Many have modern replacement window and door materials. Gardens are generally well maintained. - West end of Mill Road is an individually designed but complementary mix of 2 storey detached brick and tile houses and bungalows built from the interwar to newbuild Holkham-designed at the Mill Farm end. 3 storey Dorrington House traditionally faced in brick/flint/render with open railed seating area to front. It is located on the former site of the nineteenth century Gas Works. - Older (18c. onwards) properties come in a wide variety of sizes and are mostly brick, flint and tiled, some with coloured rendering and windows in keeping with original building style. There are buildings of the distinctive local carrstone on the corners of the Mill Road/Park Road junction. Many of the older properties have had major refurbishment and there has been infill development.
LANDMARKS	<ul style="list-style-type: none"> - The town sign, designed by a local student and carved by local artist at the junction of Mill Road & Two Furlong Hill, where planting is maintained by Wells in Bloom. - Wells Community Hospital and Heritage House Day Care Centre, further west on Mill Rd. - Dorrington House and Arch House.
GREEN & NATURAL FEATURES	<ul style="list-style-type: none"> - Mature holm oak tree with low circular brick surrounds the junction of Mill Road and Clubbs Lane next to the WTC Bowls Club entrance. A popular "pause and chat" spot. - Pollarded lime trees in the grounds of the WTC Bowls Club. - Mature horse chestnut in Blenheim House grounds. - Landscaping at the far end of Bases Lane and in the Gales Court area. - Frequent use of shingle for driveways and yards. - Some properties retain hedges. Many small yards contain shrubs and flowering plants. There are young trees and a few mature specimens within gardens.
STREETSCAPE	<ul style="list-style-type: none"> - The area is adequately lit, minimising light pollution on the ridge. - One bench on Mill Road, set back on the pavement by the eastern Gales Court pedestrian route. Second bench by Town sign at Mill Road/Park Road junction No public litter bins. - Most street surfaces are tarmac. Road signage at the town sign junction and both ends of Dogger Lane. - Boundaries are either brick and flint walls, wooden fencing or hedges. - Bus stops on Mill Road and Freeman St./Holkham Road.

Character area 2: West Central area; Land to the west of Wells Town Core	
VIEWS	<ul style="list-style-type: none"> - From properties on the ridge and the northern slope there are seaward views of the marshes, Holkham estate and Pinewoods (AONB) and to the south across the town rooftops towards farmland. - There is a long view south to the farmland on the other side of the old railway cutting from the ridge properties on the western end of Mill Road, across the triangle of land (described above) containing allotments and animal shelters. - Views along Mill Road, both sections. View down Clubbs Lane to War Memorial. View down Dogger Lane to sea wall.
POSSIBLE LOCAL GREEN SPACES	<ul style="list-style-type: none"> - Tennis Courts, Bowls Clubs, Croquet lawn. Consider for designation as recreational purposes. Planning application withdrawn due to covenant in terms of bequest. - Gales Court grassed areas, to prevent infill development.
POSSIBLE NON-DESIGNATED HERITAGE ASSETS	<ul style="list-style-type: none"> - Brick and flint walls along north side of Bases Lane and the unmade road down to Temple Court.



Figure 12: Character area 2.



Figure 13: Map showing the location of character area 3.

Character area 3: East area; Land to the East of Wells	
LAND USES	<ul style="list-style-type: none"> - Northfield Estate: Mainly residential, largely rental properties, mostly owned by a large housing association, although increasing numbers owned or managed by Homes for Wells. Some housing privately owned, mostly occupied by permanent residents. - Surrounding Northfield: Largely private residential, variable in character, (cul de sacs comprising chalet bungalows faced with brick and flint, small terraces, apartments and a range of larger houses with big gardens, ranging in age but generally 20th century. These homes increasingly provide holiday and second home accommodation. - Maryland: Large mixed use area comprising well-maintained thriving business ventures (workshops, retail, warehousing and storage) together with disused and derelict workshops and land not usefully employed. - Retail: The Chinese take away is the single retail outlet on the Northfield estate. Polka Road (known as The Polka) has The Old Railway Station Pottery, Gulf Fuel Station and the Co-op supermarket. - Community: The Primary and Nursery School with the Play Centre are to the far south of this area. The Police Station is on Polka Road.
LAYOUT	<ul style="list-style-type: none"> - Northfield Estate: Linear, regular, buildings have very long back gardens and sufficient frontages for parking although parking is mainly on the road. There is a consistent building line. - Surrounding Northfield: Development is within block like areas in terms of shape but significantly less linear with lanes/entrances providing access to buildings behind one another. - Maryland: This is built in blocks. Specific businesses occupy very large plots e.g. Orchard Caravans, interspersed with larger workshops, next to blocks of smaller workshops, only some of which are occupied. - Retail: Apart from the takeaway the remaining retail facilities in this area are on Polka Road and Maryland. - Community: The school is close to a supermarket and residential cul de sac (Bluebell Gardens), with single access onto the premises. The police station has been rebuilt with bungalows on the land to the rear. A large parking area has been retained. - There are two infill closes, Roses Court and behind the police station off Polka Road.
ROADS, STREETS, ROUTES	<ul style="list-style-type: none"> - Northfield Estate: Two way roads with pavements on both sides. An alleyway gives pedestrian access between two parts of the estate. Northfield Lane leads to footpaths towards the coastal path, and allotments, plus fields where dog walking is popular and also along the old railway cutting to East Quay and the fishermen's sheds. - Surrounding Northfield: Two way roads, usually with pavements on both sides. Access to some buildings is via unmade up roads, some single lane. - Maryland: Two way roads to all parts of the industrial estate and areas for parking, the entrance having a pavement. - Retail: Two way roads with pavements provide access to all retail facilities. - Community: The School site is on a two way road with pavements and benefits from a bus turning circle and zebra crossing. Many parents and children utilise the lane through the cemetery opposite to travel to and from school.

Character area 3: East area; Land to the East of Wells	
TOPOGRAPHY	<ul style="list-style-type: none"> - Northfield Estate: stands proud of the surrounding East Quay, allotments, paddocks and Maryland. A ridge runs through this area and provides natural protection from flooding and some views of the saltmarsh. - Surrounding Northfield: Much residential property is high like Northfield. - Maryland: Lower and vulnerable to flooding, currently protected by the East Bank (also known as the North Point) and higher flood defences. - Retail: The Old Railway Station, Gulf Fuel Station and Co-op all lie within an area traditionally considered to be at risk of flooding prior to the defences being raised. - Community: Polka Road rises from the lower lying areas above, up to the school and beyond.
SPACES	<ul style="list-style-type: none"> - Northfield Estate: The allotments, dog walks, cutting and paddocks provide open green spaces surrounding the whole area on the east. There is parking provision close to the newest houses built on the Neilson Close. Car parking elsewhere on the estate is highly visible with cars lining the road on both sides, exacerbated during holiday periods when tourists also use this area. The new buildings, built on the Neilson Close parking area, for rent and part ownership, have adequate well marked parking. This is in front of the houses although with time, cars will be screened from windows by planting, although not screened from public view. This area also benefits from a small children's playground. Northfield Crescent has a large green area. - Surrounding Northfield: Views over the marsh in the town core area are to St Nicholas Church Tower. Views along part of the length of Polka Road towards the harbour are tree lined. - The marsh/meadowland between the dismantled harbour branch railway line and Maryland/Northfield Crescent. - Maryland: Open hard surfaced aspect. - Retail: Open aspect to car parking serving the Co-op store. - Community: The turning circle by the primary school includes a garden with a small path through it and WI town sign. The extensive school playing field includes areas of the old railway track, allowed to grow naturally.

Character area 3: East area; Land to the East of Wells

<p>BUILDINGS</p>	<ul style="list-style-type: none"> - Northfield Estate: generally, buildings are constructed from redbrick and pantiles, erected between 1915 and 1967, largely semi-detached houses or 4 flats within the style of a semi-detached house, with standard UVPC windows. The earliest examples (in Northfield Avenue) were completed during World War One and have more character, coloured rendering and an entrance to the Avenue sporting two brick pillars. A few Airey 1940's houses remain. Privately owned homes have been extended to the sides, often with well-maintained gardens. Generally, structurally buildings are sound, many with new roofs, although gardens are large and both fencing and gardens are therefore time consuming to maintain so some are in need of TLC. - Surrounding Northfield: Heights, arrangements and styles vary to include detached, semi-detached, terraced and apartments but most are of traditional building materials frequently red brick and pantiles, sometimes with flint features. There is much evidence of building in areas once occupied by gardens; some houses have been demolished and replaced with an increased number of smaller dwellings. Holiday homes are increasingly appearing as cabins and attached or detached annexes. - Maryland: Smaller workshops are red brick, squares with flat corrugated metal roofs. The larger businesses have made use of the ability of modern materials to cover larger areas but retain corrugated metal and red brick, while smaller ones incorporate asbestos, corrugated iron and breeze block. The former flour mill (currently used as an antique centre and veterinary surgery) and the disused silo dominate the area to the north. - Retail: Both the take away on Northfield Lane and the pottery/bookshop in the old railway station retain the original red brick building structures (1950's with flat above/Victorian with grey slate tiles and grey canopy). The Co-op is also red brick, supported by red brick pillars between large expanses of glass with a curved metal roof and glass canopy. The Gulf Fuel Station, being self-service, consists of a simple metal canopy. - Community: The 1929 Primary School Building (former Secondary Modern School) has red pantiles, red brick, gabled frontages with fascias featured in paler yellow brick matching yellow lintels above large rectangular windows. The police station is red brick with a flint fascia, bright blue rendered frontage to the right and gently sloping grey roof.
<p>LANDMARKS</p>	<ul style="list-style-type: none"> - Northfield Estate: The bridge over the old railway line surrounding Northfield. - Maryland: the former flour mill. - Retail: The Old Railway Station. - Community: The Primary School building. The WI town sign and boat garden on turning circle next to the primary school, where planting is maintained by Wells in Bloom. The blue frontage to the police station.
<p>GREEN & NATURAL FEATURES</p>	<ul style="list-style-type: none"> - Northfield Estate: Some properties retain hedges although increasingly these are replaced with parking/fencing at the front. The few trees are found within gardens. The area to the East and South is allotments, fields, coastal path, old railway line and further fields. - Surrounding Northfield: Significant numbers of large trees, particularly horse chestnuts lining Polka Road and near Smugglers Cove. - Maryland: No green or naturally soft features; weeds growing in, over and round disused and derelict workshops. - Retail: No green or soft features. The Co-op planted the edges surrounding the car park. These edges have not been maintained and pathways through them have been created as plants are damaged by people taking the shortest route. - Community: The Primary School. The Police Station has a grassed area in front of the car park with bushes and large trees, particularly horse chestnuts and ilex. The Primary School to the front, has a grassy area, hedges and bushes. To the rear is a large playing field with trees and bushes.

Character area 3: East area; Land to the East of Wells

STREETScape	<ul style="list-style-type: none"> - Northfield Estate: The area is well lit. There is no street furniture or personalisation through public seating, planting, bins, bollards, public art or flower pots and street surfaces are tarmac. Street signage at both ends of a road differentiates the Avenue, Crescent, Lane and Waye. - Surrounding Northfield: Flint walls have been retained by homes to the East of Northfield Lane, around cottages at Maryland Corner, Mill House, near the entrance to The Saxons and to the right of the entrance to Roses Court. Smugglers Cove has a wooden sign. There is iron fencing surrounding Northfield Lodge. - Bus stop at the Co-op.
Views	<ul style="list-style-type: none"> - Northfield Estate: There are views between buildings on Northfield Waye, towards the marsh while some Northfield Waye dwellings look out onto the paddocks. Southern edges of Northfield have field views from their rear gardens. - Surrounding Northfield: View to St Nicholas Church from near the fuel station. View down Polka Road – tree lined. - Maryland: Views of the meadows and marshes to the east, and Ramm’s Marsh and the church to the west.
POSSIBLE LOCAL GREEN SPACES	<ul style="list-style-type: none"> - Northfield Estate: is an area of lawn in front of a crescent of bungalows. - Marsh/meadowland between the former harbour branch railway line and Maryland/Northfield Crescent.



Figure 14: Character area 3.



Figure 15: Map showing the location of character area 4.

Character area 4: South area; Substantially an area of post-World War 2 development

LAND USES

- Warham Road: Beyond the speed limit is the recycling centre and Midden (a caravan and camping site). New Farm buildings mainly provide for a marine/car engineer business. Warham Road, on both sides, is mainly residential with only two holiday homes at the time of writing. Near the junction with the A149, are two of the approx. dozen remaining B&B's (from a peak of 40 in 2010), a holiday letting business, art gallery, IT office and a branch of an international shipping company (Swire Shipping).
- A149 Stiffkey Road: Leaving Wells, the rear gardens of the houses on Warham Road back onto the A149. The former level crossing house on the edge of town is Jo's Abode and scrapyard, which is opposite to the entrance to Walsingham Light Railway, a tourist attraction operating steam trains and open carriages on a 260mm gauge line. The site also houses an art studio, café and shop. A Marine Centre neighbours the train station and Blue Sky camping site, which is on the right, provides more affordable sites for camping, caravans and motorhomes.
- A149 Warham Rd: California Terrace now mostly holiday homes. Opposite is Grove Road which provides a mix of housing for permanent and holiday accommodation.
- A149 Church Street/Burnt St: A mix of permanent and holiday accommodation. The Bowling Green Inn provides accommodation and is a hospitality venue.
- Market Lane: A terrace of flint cottages are now mainly holiday homes, gives way to more modern, 1970's housing. Opposite is Manor Farm, a B&B, and Manor Farm Drive. 50% of this development is occupied by permanent residents. The affordable housing terraces are part of the Staithe Place development. Most provide rental accommodation, but some part ownership properties have already lost their covenants and affordability status. Alderman Peel High School provides education for over 500 local students and some from out of the catchment area. It is a successful and popular school.
- Southgate Close/Mill Road/Two Furlong Hill: A mix of bungalows and houses (mainly housing) which are permanent residents. Of the houses, one is a B&B and another provides cycle hire.
- Burnt Street: On the corner between Burnt St and Two Furlong Hill is a Funeral Director's and across the road is a small business selling plants from one of the bungalows. Beyond them is the Fire Station, maintained by a volunteer service. Orchard Caravans is a mobile home holiday site.
- B1105: Also called the Dry Road, and a route to Fakenham, the closest Market Town.
- Staithe Place (Now Homepiece Road and Ashburton Close, named after Ashburton House positioned on its southern edge): 120 houses make up this estate, including some affordable housing both for rent and part ownership. Approximately half of the market housing on this estate are second/holiday homes.
- Waveney Close leading to Rectory Gardens: Mainly a private housing estate composed of bungalows and chalet bungalows. This is important provision for those wanting to downsize locally but is increasingly supplying the holiday home market.

Character area 4: South area; Substantially an area of post-World War 2 development

<p>LAYOUT</p>	<ul style="list-style-type: none"> - Warham Road: The relatively large houses have gardens to the front with adequate parking and long rear gardens. Plots vary in size although there is a fairly consistent building line. - A149 Stiffkey Road: Back gardens of residential property reach to this road, together with the side of the complex within which is Holiday Hideaways, Gallery Plus etc. Other forms of commerce tend to be dotted along the road and generally off the road, much out of sight. - California Terrace, constructed in the mid 19th century, has steps down to a pathway which runs between the houses and their front gardens/sheds. There is no provision for parking. Grove Road, opposite, is a 20th. century cul-de-sac, with adequate parking within the boundaries of well-spaced dwellings, with large gardens and a two way access road. - A149 Church Street/Burnt St: A variety of housing provides for both permanent residents and the holiday market. Some buildings are tightly packed, with no parking while others have driveways which are difficult to exit, along a road which suffers severe congestion as a section of the main coast road, the A149. - Market Lane: A terrace of small cottages with long narrow front gardens and very little parking, gives way to more modern, larger 1970's housing all with adequate parking and a consistent building line. Manor Farm Drive is accessed from Market Lane, comprised of very large detached and some semi-detached housing, some close together. Most cars are out of sight through design. Insufficient parking provision was made for the affordable housing at the planning stage. There is congestion on Market Lane associated with the school day. - Mill Road/Southgate Close/Two Furlong Hill: Mainly bungalows on individual well-spaced plots, together with some large houses and gardens and immediate access onto the road. - Burnt Street: A range of terraces, bungalows, larger houses set back from the road. Orchard caravans has mobile homes carefully organised to maximise use of space, interspersed with small green areas. - Staithe Place (Now Homepiece Road and Ashburton Close – after Ashburton House positioned on its far edge Southwards): The roads leading into the estate sweep with curves, have wide pavements and grass verges giving a more open, non-estate ambience and houses are better spaced, with more variety and style than other smaller estates. - Waveney Close leading to Rectory Gardens: Bungalows are fairly well spaced with some off-street parking and a fairly consistent building line.
<p>ROADS, STREETS, ROUTES</p>	<ul style="list-style-type: none"> - Warham Road. There is a pavement on one side only. Near the junction with the coast road is access to a public footpath/bridleway in an AONB of RoF with a variety of options for walks, cycling (including National Cycle Route 1) and horse rides. There is some conflict between cars and pedestrians. - A149 Stiffkey Road. The main coast road has a single pavement which provides for pedestrians leaving the Walsingham Light Railway to walk into town. This tourist attraction also provides parking. - A149 Warham Rd. This path is well used by tourists walking into town from the Light Railway and its parking facility. The pavement on the A149 is frequently blocked by cars parking on it and prams, buggies and wheelchairs are unable to get past. The same cars prevent two way traffic on the A149 causing congestion. - A149 Church Street/Burnt Street: Sections of this road are insufficient width for two way traffic flow. Pavement is intermittent, with speed restricted to 20mph. - Market Lane: Beyond the cemetery, Market Lane becomes a public footpath leading into the tranquil lanes mentioned earlier. - Southgate Close: A two way road with good pavements both sides. This consists of several cul de sacs and the main one within Mill Court provides no pedestrian exit onto Burnt St which will encourage unnecessary use of cars. - Mill Road: A two way road with good pavements both sides. Parking along the North Side is well used by residents and visitors often reducing the road to a single carriageway.

Character area 4: South area; Substantially an area of post-World War 2 development	
ROADS, STREETS, ROUTES	<ul style="list-style-type: none"> - Two Furlong Hill: A single pavement runs the length of Two Furlong Hill to the junction with Burnt Street. There is considerable congestion on this road throughout the peak periods of the holiday season, caused by the junctions with the A149 and Mill Road/Park Road, and visitor parking on the west end of Mill Road, resulting in 'gridlock' to restrict access both into and out of the town. - B1105: Two Furlong Hill becomes the B1105 as it crosses the old railway line, now another footpath. This B road is known locally as the Dry Road; the pavement stops beyond the entrance to Staithe Place. - Staithe Place (Now Homepiece Road and Ashburton Close) has footpaths on both sides, one of which leads onto Market Lane and the school. There are also pedestrian exits along Market Lane. - Waveney Close leading to Rectory Gardens: This is paved on both sides of Waveney Close, which together with Rectory Gardens, forms a cul de sac with vehicular access via one route, with a useful pedestrian access onto Burnt Street.
TOPOGRAPHY	<ul style="list-style-type: none"> - Warham Road/Stiffkey Road. Area of Outstanding Natural Beauty and Rolling Open Farmland. There are surface water drainage issues. - Market Lane, The Lane rises towards the cemetery and Rolling Open Farmland. - Mill Road/Southgate Close. Bordered by residential dwellings on both sides. - Two Furlong Hill. Residential dwellings on one side look towards paddocks and allotments. The Hill rises steeply either side of the Burnt Street junction. - Burnt Street. Bordered by residential dwellings on both sides, this low lying road is prone to flooding. - Staithe Place (Now Homepiece Road and Ashburton Close). Cul de sacs with housing on both sides interspersed with green spaces. This is the most recent large development in Wells comprising 120 houses.
SPACES	<ul style="list-style-type: none"> - A149 Warham Road. A sign advising on parking spaces still available on beach road has successfully reduced the numbers of cars accessing the town centre. - Market Lane. A cemetery, for more recent residents together with war graves from WWII. There remains space within this well looked after area with good views as far as New Farm. - Two Furlong Hill. - Allotments and paddocks. - Staithe Place (Now Homepiece Road and Ashburton Close). - Children's play area and green spaces.

Character area 4: South area; Substantially an area of post-World War 2 development

BUILDINGS	<ul style="list-style-type: none"> - Warham Road/Stiffkey Road. The houses were built between the 1930's to 50's, one or two storeys, mostly detached, brick and pantile or slate, some rendered, usually with modern double glazed window units. The former Coronation Garage, constructed inter-war, makes a distinctive contribution to the junction. - A149 Warham Road. California Terrace is a row of 6 flint cottages, (19th century). The Old Rectory (originally Georgian) set in a large area of land, provided for the development of The New Rectory (now Woodlands- 1970's), Westley House (built between 2000-2010 of green oak) and Rectory Gardens (built after Waveney Close, 1980's). - A149 Church Street/Burnt Street (left side, from Stiffkey Road): A mix of bungalows, terraced houses, houses, both old and new, flint cobbles and carrstone to red brick, some full of character, others box shaped. The Bowling Green Inn dates from the 18th. century and a development of flint fascia houses/ chalets were built on the old bowling green behind the Inn around 2000. A similar development, at around the same time, was built behind the White House, which retains some garden and mature trees. - Market Lane. Manor Farm Drive is comprised of very large detached (up to 6 bedrooms) and semi-detached very square houses, built in the first years of this century of brick and pantile, with small green areas and a driveway to Manor Farm Barns. The old Manor Farm barns were developed to reflect the vernacular as second or holiday homes. Beyond the terrace are 1970's style chalet bungalows of red brick and pantile. Some have been modernised with grey UPVC windows and doors. - Mill Road/Southgate Close: Mainly 1960's, 1970's and 1980's detached bungalows and red brick detached houses with gardens. - Mill Road (South Side from Southgate Close): Large houses, set back, from 1930's to 1960's. Often red brick and pantile, some rendered. - Two Furlong Hill: Large, generally red brick houses and bungalows with off street parking, From 1930's to 2010. - Burnt Street: Beyond the funeral directors are converted barns with one remaining derelict. Just before Plummer's Hill are two 1970's chalet properties. Burnt Farmhouse is opposite, Orchard Caravans. It is a traditional brick and flint building with more modern red brick dwellings in the grounds of what was once Burnt Farm. - Staithe Place, (Homepiece Road and Ashburton Close) : The most recent large housing development in Wells, consists of a mix of red brick, yellow Holkham like brick or render, slate or pantile with modern window and doors systems. Some are in the style of the Georgian houses on the Buttlands but generally the dwellings have been built in the style generically adopted by the developers (Hopkins Homes) and so largely shared with all the other estates Hopkins have built, regardless of their location within Norfolk. Some are large (up to 6 bedrooms) while others are apartments and terraces. - Market Lane: These red brick, pantiled, terraced houses are located on the outskirts of the main estate. - Waveney Close leading to Rectory Gardens: This development of mainly bungalows, initiated in 1964, is interspersed with a few houses/chalet bungalows: This was a residential area but is increasingly used as holiday homes with new driveways and easy maintenance, low porosity, front gardens. Rectory Gardens are more standard Norfolk coastal built being red brick and flint.
LANDMARKS	<ul style="list-style-type: none"> - Warham Road: The Old Water Tower. - Market Lane: The cemetery and APHS. - Mill Road: The town sign which was designed by a local student and carved by a local artist. - Two Furlong Hill: The Toll House. - Staithe Place (Now Homepiece Road and Ashburton Close): Ashburton House.

Character area 4: South area; Substantially an area of post-World War 2 development	
GREEN & NATURAL FEATURES	<ul style="list-style-type: none"> - Warham Road/Stiffkey Road: Views and mature trees to the saltmarsh and sea. The public footpath/bridleway is lined with oak and walnut trees. The farmland and some housing are lined with ancient hedges and many houses retain hedging and mature trees. - A149: The former railway cutting leading to APHS has mature natural regeneration. Many houses retain hedging and mature trees. - B1105: Farmland lined with ancient hedging. - Staithe Place (Homepiece Road and Ashburton Close): The estate is well catered for with green landscaped spaces.
STREETScape	<ul style="list-style-type: none"> - Warham Road/Stiffkey Road: There are no street lamps in keeping with the area, which still enjoys dark skies. - The remainder of the area has street lighting. - There are no benches in the area, surface materials are nearly always tarmac, with some shingle drives and increasingly resin and stone used for holiday homes. Signage is purely for cars and parking. More brown signs, e.g. to indicate the location of APHS would be a useful addition.
VIEWS	<ul style="list-style-type: none"> - Warham Road/Stiffkey Road. Views of Rolling Open Farmland and Saltmarsh within an AONB. - Market Lane. The land runs beside the cemetery, a peaceful large open area with views of the countryside all the way to New Farm. - Two Furlong Hill: all with views towards the paddocks on the other side of the road. - B1105: the approach on the Dry Rd affords views over farmland and the built up area of the town.
POSSIBLE LOCAL GREEN SPACES	<ul style="list-style-type: none"> - Warham Road: The former railway cutting. - Market Lane: The cemetery. - Mill Road: The green with the town sign. - Two Furlong Hill: The paddocks. - Staithe Place (Homepiece Road and Ashburton Close): Several landscaped areas and the children's play area. - The turning circle at the Primary School with the WI sign.
POSSIBLE NON-DESIGNATED HERITAGE SITES	<ul style="list-style-type: none"> - California Terrace. - Warham Road: Old water tower. - Town sign near Arch House. - WI sign at the Primary School turning circle. - Manor Farm and New Farm.



Figure 16: Character area 4.

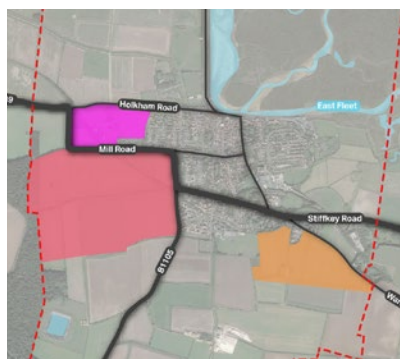

Figure 17: Map showing the location of character areas 5-7.

Character area 5: South West area; farmland and allotments lying south of Mill Road and West of Two Furlong Hill

LAND USES	<ul style="list-style-type: none"> - The triangle delimited by Mill Road, Two Furlong Hill and the former railway line to Heacham is allotment land so designated in 1948. It has been the subject of various proposals for development - in 1972 by the then UDC and in 1994 by the Town Council – and part of which, excluding the allotment gardens, has been offered by the town Council in the Call for Sites in 2021. - The allotment land is partly divided into individual plots and partly, to the east consists of several paddocks on which there are stables. - South of the railway embankment and cutting is given over to farmland, bisected by a farm track running east west from which another track runs north to Mill Road. - The Community Hospital stands at the north west end of Mill Road. The former nurses’ home is now a day centre for the elderly, known as Heritage House.
LAYOUT	<ul style="list-style-type: none"> - The hospital stands back from the road with a car park in front. The day centre is to its west in separate grounds and is similarly located.
ROADS, STREETS, ROUTES	<ul style="list-style-type: none"> - The roads on the boundary of the area (Mill Road/Two Furlong Hill North (A149) and Two Furlong Hill South (B1105)) are subject to significant congestion, even gridlock, at the peak holiday periods.
TOPOGRAPHY	<ul style="list-style-type: none"> - Mill Road lies on the east west road on top of the ridge which runs parallel to the coast road. The land falls away sharply to the railway embankment rising to the west so that the point at which the railway track crosses Mill Road it is in a cutting some twenty feet deep. The track which bisects the area runs along the bottom of the hill south of which the land once again rises.
SPACES	<ul style="list-style-type: none"> - As above the allotment land consisted originally of a hundred plots but many of these have been combined.
BUILDINGS	<ul style="list-style-type: none"> - The hospital was built prior to World War One and has a pitched roof and is partly on two floors. It is built of brick with a deep pitched roof. Heritage House, which was built post-World War Two, is of more modern, functional construction. The buildings together represent a significant development in an otherwise undeveloped area,
LANDMARKS	<ul style="list-style-type: none"> - The Community Hospital. - Heritage House.
GREEN & NATURAL FEATURES	<ul style="list-style-type: none"> - There are several well-maintained hedgerows bordering the agricultural fields and Green Neuk (also known today as Green Lane), and substantial natural regeneration associated with the old West railway line.
STREETScape	<ul style="list-style-type: none"> - Hedgerows.
Views	<ul style="list-style-type: none"> - The paddock offers a pleasant view to houses on both roads across the landscape.
POSSIBLE LOCAL GREEN SPACES	<ul style="list-style-type: none"> - Allotments.
POSSIBLE NON-DESIGNATED HERITAGE ASSETS	<ul style="list-style-type: none"> - Community Hospital.

Character area 6: West area; farmland used partly for horses and caravans and for Christmas trees

LAND USES	- The land is an active tenanted farm, and used for agriculture, a commercial livery, and a caravan site. The old railway line divides the holding and there is a Christmas tree plantation to the north of the site.
LAYOUT	- There is a farmhouse and adjacent buildings, including stabling.
ROADS, STREETS, ROUTES	- The land is defined by the east west Holkham Road from Freeman Street, the arterial A149 which runs north/south and then west/east as Mill Road, running along the ridge from the hill at the top of Mill Road (one of the town's high points) to Wells. This road is subject to significant congestion during peak holiday periods, resulting in gridlock on several occasions.
TOPOGRAPHY	- The land is on the north side of the ridge which runs from Wells to Holkham, falling to the reclaimed marshes to the north. This is currently a 'dark area' defining the edge of the built up area and is a feature that merits retention.
SPACES	- It is farmland.
BUILDINGS	- There are no buildings other than the farmhouse and outbuildings as above.
LANDMARKS	- The area makes a significant contribution to the urban form of the town as seen from the Norfolk Coastal Path to the north, as well as to the AONB of which it is part.
GREEN & NATURAL FEATURES	- There is substantial mature tree cover around the farmhouse, and around adjoining meadows. There is a Christmas tree plantation.
STREETScape	- This is a 'dark' area.
Views	- There are fine views from the area, including from Mill Road, out to the marshes and flooded fields to the north and of farmland to the south.
POSSIBLE LOCAL GREEN SPACES	- It is all green.
POSSIBLE NON-DESIGNATED HERITAGE ASSETS	- The farmhouse is of Georgian appearance, although is probably Victorian, and is well known locally.

Character area 7: South East area; farmland south of the old railway line

LAND USES	- Farmland including narrow gauge railway station and water pumping site. - It lies wholly outside the development boundary of the town.
LAYOUT	- Buildings in the area include New Farm (formerly known as Temple's Farm) built in 1888 which complex lies next to the track leading from the former water tower.
ROADS, STREETS, ROUTES	- Double track as above.
TOPOGRAPHY	- The land rises to the pumping station and falls to both the west, south and east.
LANDMARKS	- Water tower.
GREEN & NATURAL FEATURES	- The track has a hedge on either side.
Views	- The land beyond the school is open country with a view up the hill across farmland. - From the water tower is a fine view northeastwards towards Blakeney Point. - The road entry along Warham Road comes through open country to an avenue of trees.
POSSIBLE LOCAL GREEN SPACES	- Area around the water tower could be recreational open space.
POSSIBLE NON-DESIGNATED HERITAGE ASSETS	- The water tower is a twentieth century feature unlike most equivalents elsewhere. Species of owls and bats nest in it.



Figure 18: Character areas 5-7.

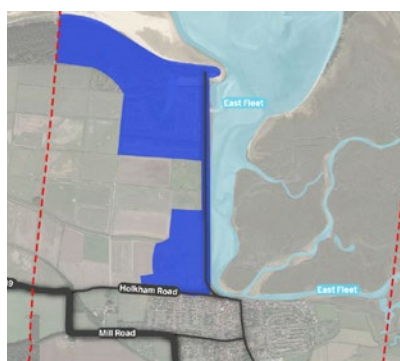

Figure 19: Map showing the location of character area 8.

Character area 8: Beach area; reclaimed marshland providing recreation and beach facilities	
LAND USES	<ul style="list-style-type: none"> - Recreational, retail, leisure, commercial and sewage treatment plant, set in an Area of Outstanding Natural Beauty (AONB). - The area known as the 'Pinewoods' is extensively developed for holiday and recreational uses and comprises leasehold chalets (part-time residential), a static caravan site (part-time residential) and a touring caravan site (season only), supported by food and retail outlets, a children's play area, washing and administrative facilities. There is an extensive car park. - Lifeboat Station. - New Lifeboat Station under construction. - The playing field complex near the Quay includes a football pitch, pavilion and children's play area. - A car park adjoins the playing field, with the sewage treatment plant to the north. - There is an occasional extensive car park to the north of the playing field, accessed from Freeman Street.
LAYOUT	<ul style="list-style-type: none"> - The developed area of 'the Pinewoods', and the playing fields are linked by a 1 km road and a light railway line, recently dismantled. - The caravan sites and chalets have a formal layout, with supporting uses on the periphery and the washing facilities located throughout the sites.
ROADS, STREETS, ROUTES	<ul style="list-style-type: none"> - Private road to the beach. - A privately run railway from the town to the caravan sites, in operation from 1976 to 2021, now dismantled on the retirement of the operators and the land reverting to management by the Holkham Estate. - Two footpaths on the sea defence bank, known as the Beach Road Bank, link the town to the beach. - The Norfolk Coastal Path runs through the entire zone.
TOPOGRAPHY	<ul style="list-style-type: none"> - This zone is part of a designated AONB. - It is flat, reclaimed marshland, with brackish water drainage, and has been flooded by tidal waters twice in 65+ years. - The marshland is bordered by the town to the south, sea defences to the east, sand dunes and pinewoods (Meals) to the north and extends 4-5 miles to the west. 400m. to the west of the road/ railway, the area is a designated National Nature Reserve.
SPACES	<ul style="list-style-type: none"> - Football pitch. - Children's play areas at both the 'Pinewoods' and the town end. - Car parks at both the 'Pinewoods' and the town end, and occasional car park in the middle.
BUILDINGS	<ul style="list-style-type: none"> - The football pavilion, sewage treatment plant, café, shops, washing and administration facilities are all single storey and mostly brick and tile construction. They have a 'sea-side' appearance. - The new lifeboat station and the new one are effectively two storeys high, with curved roofs which complement their situation in the beach landscape.

Character area 8: Beach area; reclaimed marshland providing recreation and beach facilities

LANDMARKS	<ul style="list-style-type: none"> - The marshland and pinewoods forming part of the AONB. - The old Lifeboat Station and the new one.
GREEN & NATURAL FEATURES	<ul style="list-style-type: none"> - There are extensive pinewoods (meals) growing on the sand dunes, comprising maritime, corsican and scots pines. - The developed area of the 'Pinewoods' is screened by natural regeneration of silver birch, etc., reinforced by deciduous planting. - Broom, rushes and rough scrub beside the Beach Road and railway line. - Sea buckthorn on the east side of the Beach Road Bank, at the northern end, and variety of wildflowers along beach bank.
STREETSCAPE	<ul style="list-style-type: none"> - Street lighting throughout the caravan and chalet sites. - Benches on the Bank footpaths, at the railway terminals, playgrounds, etc. - Extensive signage to beach, including information on carparking, footpaths, etc.
VIEWS	<ul style="list-style-type: none"> - Iconic views of the town. - Views of the agricultural fields west of town to the woods of Holkham Park and its Monument. - Views over the marshland and Meals to the west. - From the Beach Road Bank, views over the salt marshes to the east. - From the playing field, extensive views over the marshland and pinewoods.
POSSIBLE LOCAL GREEN SPACES	<ul style="list-style-type: none"> - Area is an AONB. - Playing fields. - Marshlands and pinewoods. - Abraham's Bosom the former boating lake which was once the mouth of West Fleet a creek which ran through the marshes from Holkham village.
POSSIBLE NON-DESIGNATED HERITAGE ASSETS	<ul style="list-style-type: none"> - Lifeboat Station (now being replaced).





03

Design guidance and codes

3. Design guidance and codes

3.1. Introduction

The aim of this document is to ensure that future development within Wells-next-the-Sea is well-designed and built to last. This document focuses on the existing distinctive characteristics of the parish, showing how they can be incorporated into new development, with the aim of maintaining and, where possible, enhancing the local ambience.

This section sets out best practice examples from Wells-next-the-Sea, demonstrating how the existing context can serve as a reference point and an inspiration for new development that is sensitive to the existing place.

Reference to existing character does not, however, rule against contemporary approaches to design, but it does require a more nuanced and sensitive design approach to avoid inappropriate design solutions. The elements that are more general are what we mean by design guidance. Other elements that are more prescriptive or set out parameters are the design codes.

This chapter is divided into 8 sections, shown on this page, each one with a different number of subsections. Each section and subsection is numbered (e.g. DC.1) to facilitate its reading and consultation. A short introductory text with more general design guidance is provided at the beginning of each section followed by a series of more prescriptive codes and parameters highlighted in a light-green box.

The table on the next page links the design guidance and codes to the different character areas identified within the parish. Cells marked with an **X** identify the character areas to which the guidance and codes relate.

DC.1	Layout, grain and pattern of development
DC.2	Access and movement
DC.3	Relationship with the street and other spaces
DC.4	Shop fronts
DC.5	Development affecting heritage assets
DC.6	Building scale and form
DC.7	Architectural styles, materials and details
DC.8	Open space
DC.9	Sustainable design

DC.1 Layout, grain and pattern of development

DC.1.1 Layout and grain

DC.1.2 Pattern of development

DC.2 Access and movement

DC.2.1 Roads

DC.2.2 Parking

DC.2.3 Legibility and wayfinding

DC.3 Relationship with the street and other spaces

DC.3.1 Overlooking the public space

DC.3.2 People-friendly streets

DC.3.3 Street planting

DC.3.4 Street lighting

DC.3.5 Enclosure

DC.3.6 Corner treatment

DC.4 Shop fronts

DC.4.1 Signage

DC.4.2 Lighting

DC.4.3 Safety

DC.4.4 Good examples of shop front design

DC.4.5 Shop front design next to the sea

DC.5 Development affecting heritage assets

DC.6 Building scale and form

DC.6.1 Scale, form and massing

DC.6.2 Building lines and boundary treatments

DC.6.3 Infill development and housing extensions

DC.6.4 Density

DC.6.5 Building conversions

DC.6.6 Roofline

	Ch. area 1	Ch. area 2	Ch. area 3	Ch. area 4	Ch. area 5	Ch. area 6	Ch. area 7	Ch. area 8
DC.1.1 Layout and grain	X	X	X	X	X	X	X	X
DC.1.2 Pattern of development	X	X	X	X				X
DC.2.1 Roads	X	X	X	X				X
DC.2.2 Parking	X	X	X	X				X
DC.2.3 Legibility and wayfinding	X	X	X	X	X	X	X	X
DC.3.1 Overlooking the public space	X	X	X	X				
DC.3.2 People-friendly streets	X	X	X	X				
DC.3.3 Street planting	X	X	X	X				
DC.3.4 Street lighting	X	X	X	X				
DC.3.5 Enclosure	X	X	X	X				
DC.3.6 Corner treatment	X	X	X	X				
DC.4.1 Signage	X							
DC.4.2 Lighting	X							
DC.4.3 Safety	X							
DC.4.4 Good examples of shop front design	X							
DC.4.5 Shop front design next to the sea								X
DC.5 Development affecting heritage assets	X	X	X	X				X
DC.6.1 Scale, form and massing	X	X	X	X				
DC.6.2 Building lines and boundary treatments	X	X	X	X	X	X	X	X
DC.6.3 Infill development and housing extensions	X	X	X	X				
DC.6.4 Density	X	X	X	X				
DC.6.5 Building conversions	X	X	X	X				
DC.6.6 Roofline	X	X	X	X				

DC.7 Architectural styles, materials and details

DC.7.1 Architectural details

DC.7.2 Materials and colour palette

DC.7.3 Building proportion

DC.7.4 Windows

DC.7.5 Doors

DC.7.6 Chimneys

DC.8 Open space

DC.8.1 Open space

DC.8.2 Biodiversity and wildlife

DC.9 Sustainable design

DC.9.1 Sustainable design

DC.9.2 Net-zero carbon

DC.9.3 Solar roof panels

DC.9.4 Green and brown roofs

DC.9.5 Sustainable drainage systems

DC.9.6 Resilience to sea-level rise

DC.9.7 Storage and slow release

DC.9.8 Permeable paving

	Ch. area 1	Ch. area 2	Ch. area 3	Ch. area 4	Ch. area 5	Ch. area 6	Ch. area 7	Ch. area 8
DC.7.1 Architectural details	X	X	X	X				
DC.7.2 Materials and colour palette	X	X	X	X				
DC.7.3 Building proportion	X	X	X	X				
DC.7.4 Windows	X	X	X	X				
DC.7.5 Doors	X	X	X	X				
DC.7.6 Chimneys	X	X	X	X				
DC.8.1 Open space	X	X	X	X	X	X	X	X
DC.8.2 Biodiversity and wildlife	X	X	X	X	X	X	X	X
DC.9.1 Sustainable design	X	X	X	X				X
DC.9.2 Net-zero carbon	X	X	X	X				X
DC.9.3 Solar roof panels	X	X	X	X				X
DC.9.4 Green and brown roofs	X	X	X	X				X
DC.9.5 Sustainable drainage systems	X	X	X	X	X	X	X	X
DC.9.6 Resilience to sea-level rise	X	X	X		X			X
DC.9.7 Storage and slow release	X	X	X	X				X
DC.9.8 Permeable paving	X	X	X	X				X

3.2. Guidance and codes for Wells-next-the-Sea

DC.1 Layout, grain and pattern of development

DC.1.1 Layout and grain

Future developments should be sympathetic to local character and history, and establish or maintain a strong sense of place. Understanding and appreciating the local historic environment and the different character areas can help to ensure that potential new development is properly integrated with the existing settlement and does not result in the loss of local distinctiveness. Therefore, some guidelines for future development are:

- i. Development should sustain or enhance the characteristic and historic locally distinctive grain of development with its mix of form, layout and size;
- ii. Siting and layout of new development must be sympathetic to the character of the area and must respect the heritage of the town. Proposals near the historic part of the town and north of the west central character area should respect the characteristic linear street layout; and
- iii. Development which does not reflect the current grain of the town must be avoided. Proposals need to consider existing density and the relationship between buildings and plot sizes.



Figure 20: The character area to the east of the town centre is characterised by a connected street pattern and some cul-de-sac roads with well-sized front gardens, pavements and on-plot car parking.

DC.1.2 Pattern of development

Any future development should reflect the local context ensuring that it makes a positive contribution to the existing built form.

To ensure a good fit between new and old it is important that any new development seeks to conserve and enhance the character of the existing settlement in terms of urban form as well as character. Therefore, some guidelines for new development are:

- i. Development affecting the transitional edges between a settlement and the surrounding countryside must be softened by new landscape planting to provide a more harmonious interface between built development and the wider landscape;
- ii. Development that alters the existing roofline or blocks existing long distance views to the waterfront should be avoided; and
- iii. New development should be limited in extent and well-integrated with the landscape and the existing settlement pattern and vegetation.



Figure 21: The historic town centre and part of the west central character area are characterised by linear streets and lack of pavements and front gardens. The majority of the building types are terraced housing creating a continuous frontage.

DC.2 Access and movement

DC.2.1 Roads

The street layout in Wells-next-the-Sea reflects the historic origins at its core, as well as its later town character and modern development. The A149 and B1105, running from east to west and north to south respectively, are the principal routes which connect the town to the surrounding settlements. Branching out are mostly connected streets leading to the town centre and the waterfront as well as residential areas. There are some cul-de-sacs in residential neighbourhoods, whilst public rights of way provide connections mainly to the north along the waterfront and to the south of the town.

Street design for new development should adopt an interconnected street layout to allow traffic to be distributed more evenly across the network and reduce congestion. A connected street network would encourage the use of active travel including walking and cycling and would generate a higher level of pedestrian activity. This would promote chances of social interactions and enhance natural surveillance at street level while promoting accessibility of services and emergency vehicles. Some guidelines for future development are:

- i. Street layouts within development sites should be connected where possible and should connect to the wider area and to public footpaths;
- ii. Street hierarchy must be clear and legible. Main, secondary streets and private lanes have different character, in terms of width of carriageway, pavement, parking spaces, street trees and can therefore, support different levels of traffic;
- iii. Street design must incorporate opportunities for landscaping (street trees and green verges) and sustainable drainage solutions (e.g. bioretention trees);
- iv. Opportunities for cycling should be provided, where possible, taking into account the narrow streets and the occasional lack of pavements; and

- v. New development should include streets that incorporate the needs of pedestrians including disable people with electric buggies. In particular, pavements should be wide enough to allow for the latter to move easily, whilst traffic calming measures, like raised tables or crossings, should be introduced along the carriageway.



Figure 22: Subtle meandering streets provide an interesting visual result for pedestrians and drivers.



Figure 23: Footpaths should be an integral part of the design to encourage alternative ways of transport.

Main entrances to the town

The existing entrances to the town have in recent years lost their open views to the countryside being somewhat abrupt in their aspect. Attempts should be made to soften this with tree planting and appropriate developments should maintain the connection to the countryside. Therefore, some design guidelines for future development are:

- i. Opportunities to include green infrastructure, hedges, and/or private gardens to soften the edges must be maximised;
- ii. Provide front gardens and street planting along the main entrances to contribute to the general feeling of openness in the area;
- iii. Main entrances serve as accesses to the town. This role can be highlighted by providing planting and appropriate signage on the junctions. This will create a welcoming character;
- iv. Green verges and street trees should be integrated in the design, where possible, to create attractive neighbourhoods and provide shade to pedestrians and cyclists;

- v. Off-street parking is preferred, but where on-street parking is proposed, it should be interspersed with trees to avoid impeding moving traffic or pedestrians; and
- vi. Provide a planting buffer and landscaping between the edge of the carriageway and the countryside in order to provide transition and control pedestrian accessibility where required. The use of hedgerows where edge lanes face onto agricultural land is particularly encouraged. This buffer futureproofs the development against potential development that might front onto the edge lane in the future.

- 1** Shared lane (local access) - width to vary.
- 2** Green verge with trees or hedges. The latter are optional but would be positive additions. Parking bays to be interspersed with trees to avoid impeding moving traffic or pedestrians.
- 3** Footway.
- 4** Residential frontage with boundary hedges and front gardens.
- 5** Green space and potential for implementing swales into the landscaping.

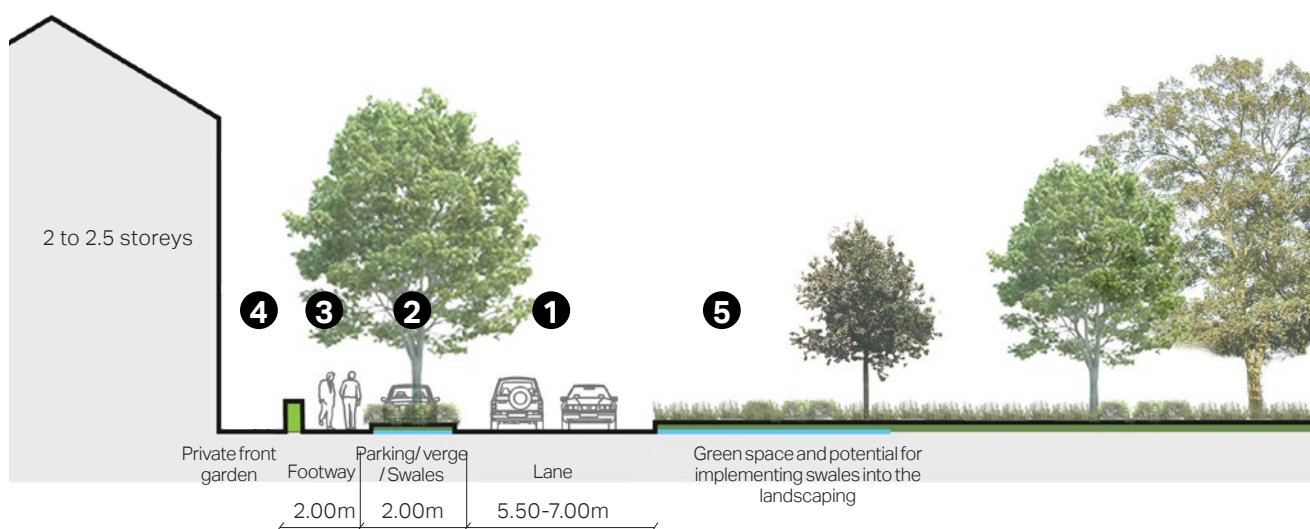

Figure 24: Section showing indicative dimensions for main entrances.

Main streets

This street provides the main access spine of a new development and connects it to the rest of the settlement. It will carry most of the heavy traffic, whilst the rest of the street network will only carry low neighbourhood traffic. The design guidelines for this street typology are:

- i. Main streets should promote the existing countryside by preserving any type of green asset;
- ii. Provide front gardens and street planting along the main streets to contribute to the general feeling of openness in the area;
- iii. Where possible, locate parking to the side of properties and consider using garages to mitigate the impact of cars on the streetscape. Planting and vegetation on the front gardens and sides of the properties can also help improve the aesthetics of the environment;

- iv. Planting on street corners, junctions, and at the end of vistas can help with wayfinding and serve as open spaces in their own right;
- v. Green verges and street trees should be integrated in the design, where possible, to create attractive neighbourhoods and provide shade to pedestrians and cyclists;
- vi. Where on-street parking is proposed, it should be interspersed with trees to avoid impeding moving traffic or pedestrians; and
- vii. Cycle lanes are encouraged on main streets to promote alternative methods of transportation.

- 1** Shared carriageway (neighbourhood traffic). Traffic calming measures may be introduced at key locations.
- 2** Footway.
- 3** Green verges and street trees.
- 4** Residential frontage with boundary hedges and front gardens.

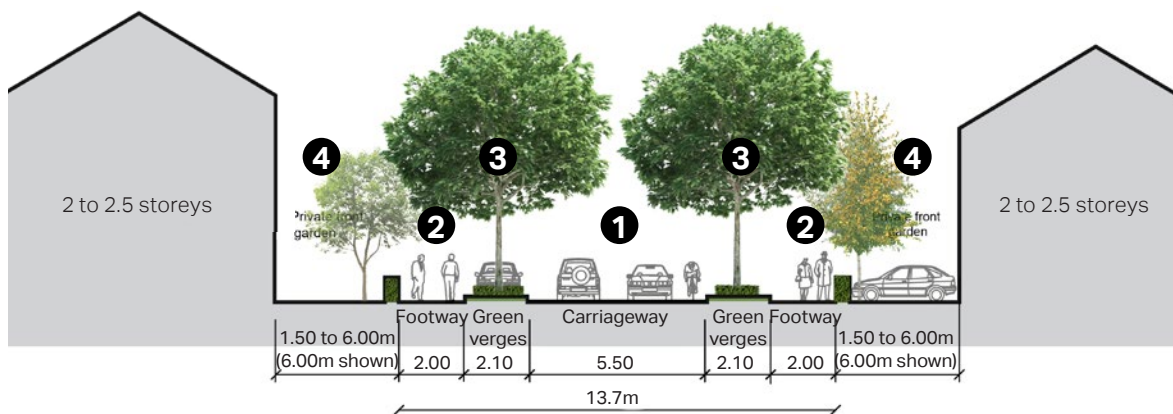

Figure 25: Section showing indicative dimensions for residential streets with green verges.

Residential streets

Residential streets have a strong residential character and provide direct access to residences from the secondary roads. They must be designed for low traffic volumes and low speed. The lane width can vary to discourage speeding and introduce a more informal and intimate character. Variations in paving materials and textures can be used instead of kerbs or road markings. The design guidelines for this street typology are:

- i. Carriageways must accommodate two-way traffic and footways with a 2.00m minimum width on either side, where possible, to meet the needs of a wide range of people including disabled with electric buggies;
- ii. Green verges and street trees should be integrated in the design, where possible, to improve the visual result and create good quality neighbourhoods;
- iii. Residential frontages should be accommodated with rich vegetation and planting in order to provide a virtual separation between public and private spaces and secure privacy for the owners; and
- iv. Where on-street parking is proposed, it should be interspersed with trees to avoid impeding moving traffic or pedestrians.

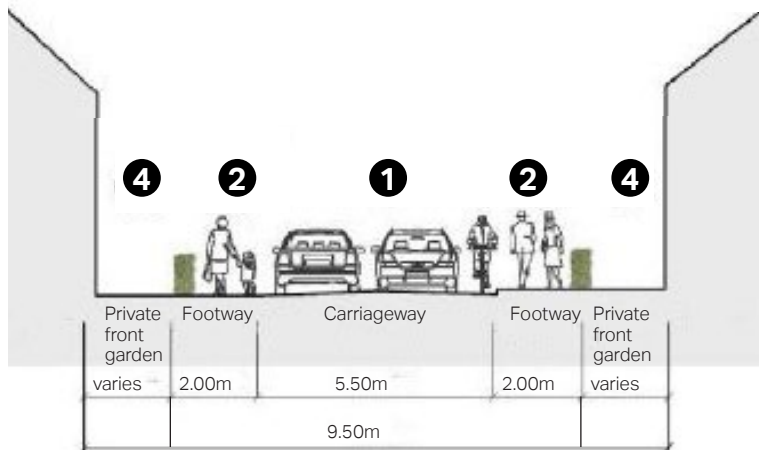

Figure 26: Section showing indicative dimensions for residential streets.

Private drives

Lanes and private drives are the access-only types of streets that usually serve a small number of houses. The design guidelines for this street typology are:

- i. Lanes and private roads should be minimum 6.00m wide and serve all types of transport modes including walking and cycling, and allow sufficient space for parking manoeuvre; and
- ii. Opportunities to include green infrastructure, hedges, and/or private gardens to soften the edges must be maximised.

- 1 Shared carriageway (neighbourhood traffic). Traffic calming measures may be introduced at key locations.
- 2 Footway.
- 3 Green verges and street trees.
- 4 Residential frontage with boundary hedges and front gardens.

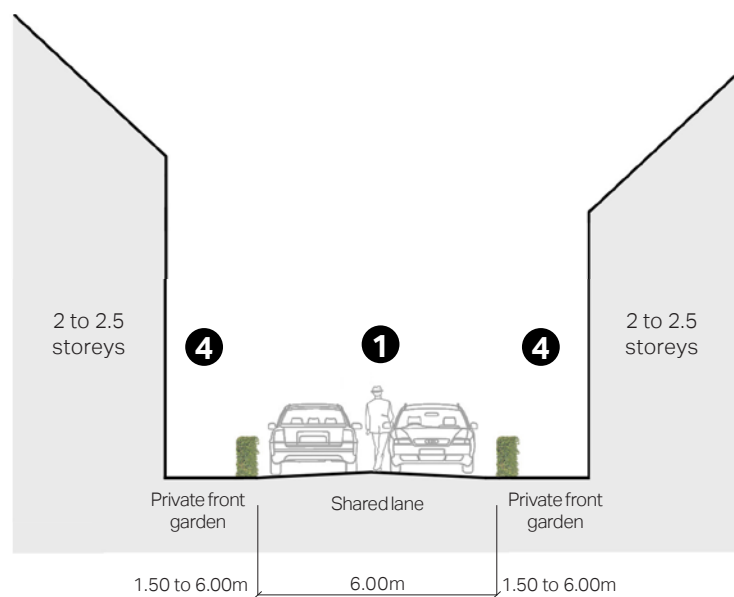

Figure 27: Section showing indicative dimensions for lanes and private drives.

DC.2.2 Parking

Visitor parking

Wells is highly popular with tourists but struggles to find adequate space at busy times, both for the beach and the town.

Additional sites may be brought forward for visitor parking. These sites should follow particular design standards to minimise environmental impact.

- i. Use of permeable paving, instead of concrete, to improve aesthetics, allow the area to have a flexible use, not merely serve as car parking, and create resiliency in flooding and sea-level rise;
- ii. If the potential site is already a grass land area, a park-on-grass solution is suggested so as to maintain the ground material; and
- iii. Encourage physical boundary treatments (trees, bushes, flowerbeds, hedgerows) to create a green screening between pedestrians and parked cars as well as mitigate car dominance.



Figure 28: Examples of permeable sustainable materials that are durable and can manage surface water run-off. (Source: <https://gridforce.co.uk/car-parks>).

Residential Parking

The demand for private cars still remains high, at the time of writing, and therefore car parking has to be carefully integrated into neighbourhoods. A good mix of parking types should be deployed, depending on, and influenced by location, topography and market demand. The main types to be considered are shown in this section.

- i. Vehicle parking should be mainly provided on-site. In general, the approach to the provision of parking should be flexible not only with the types of parking solutions but also the use of parking spaces over time. For example, the use of off-site parking facilities may be adapted depending on the long-term evolution of parking demand to serve different mobility needs such as car clubs, scooters, or bicycle storage;
- ii. Car parking design should be combined with landscaping to minimise the presence of vehicles;
- iii. Parking areas and driveways should be designed to minimise water run off through the use of permeable paving;
- iv. For small dwelling clusters, a front or rear parking court is acceptable. It is important to also introduce vegetation and appropriate boundary treatment to soften the presence of cars. For family homes, cars may be placed at the front or side of the property, the latter being preferred;
- v. When placing parking at the front, the area should be designed to minimise visual impact and to blend with the existing streetscape and materials. The aim is to keep a sense of enclosure and to break the potential of a continuous area of car parking in front of the dwellings by means of walls, hedging, planting, and use of differentiated quality paving materials.

A very useful website that helps define appropriate car parking solutions depending on the type of development is <http://www.spacetopark.org/>. This resource should be used as a design tool in new developments.

On-plot front or side car parking

Some design guidelines for on-plot front and side car parking are:

- i. Sufficient and accessible off-road car parking must be provided on site or in the nearby vicinity to cater for the use proposed;
- ii. Parking on development sites should be well integrated so as not to dominate the public realm and must adhere to Local Plan adopted parking standard or guidelines;

- iii. High-quality and well-designed soft landscaping should be used to increase the visual attractiveness of the parking. Boundary treatments such as hedges, trees, flowerbeds and low walls also increase attractiveness and provide a clear distinction between public and private space; and
- iv. Hard standing and driveways must be constructed from porous materials to minimise surface water run-off.

- 1** Front parking with part of the surface reserved for soft landscaping. Permeable pavement to be used whenever possible.
- 2** Side parking set back from the main building line. Permeable pavement to be used whenever possible.
- 3** Boundary hedges to screen vehicles and parking spaces.

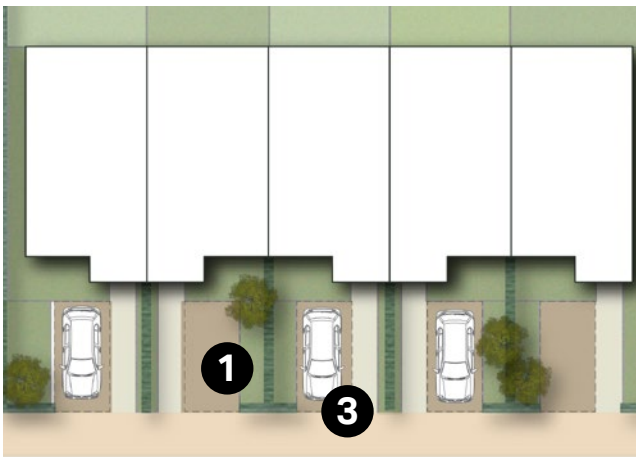

Diagram showing indicative layout for on-plot front parking.

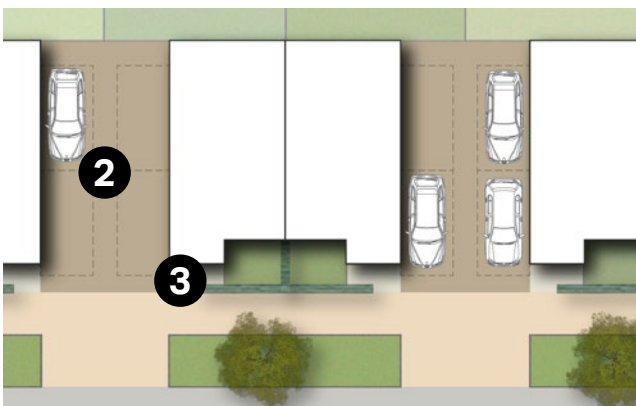

Diagram showing indicative layout for on-plot side parking.

Figure 29: On-plot car parking layouts.



Figure 30: Local example of on-plot front parking typology.



Figure 31: Local example of on-plot front parking typology.

On-plot garage

Where provided, garages must be designed either as free-standing structures or as additive form to the main building to ensure continuity of the building line. Some design guidelines are:

- i. Garages must complement and harmonise with the architectural style of the main building rather than forming a mismatched unit. They must also not result in excessively small and overshadowed gardens;
- ii. Garages need to be large enough to accommodate a modern, family sized car and some storage. Based on *North Norfolk Core Strategy - Parking Standards C (September 2008)*, garages will be counted as car parking spaces where they have a minimum internal dimension 7m x 3m. This dimension prevents turning the garages into habitable or merely storage spaces; and
- iii. On-plot parking can be located either to the front or the side of the building and can be a covered car port or open.



Figure 32: Local example of on-plot garage typology.

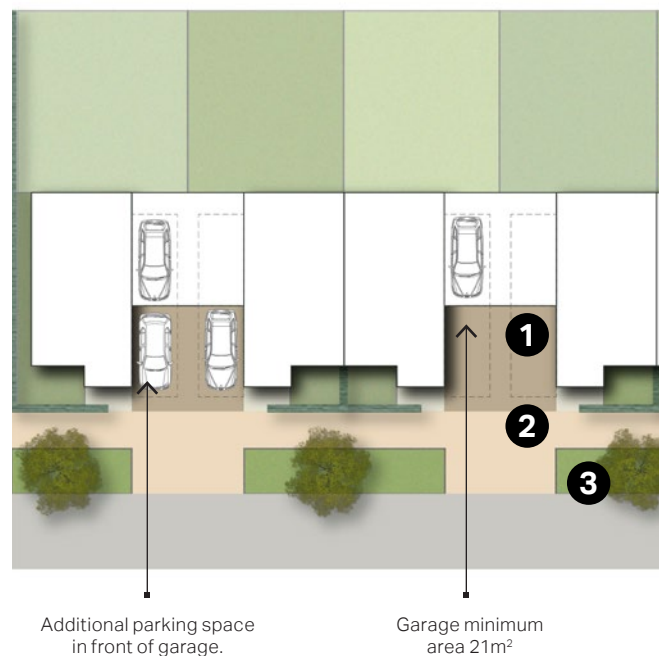

1 Side parking set back from the main building line. Permeable pavement to be used whenever possible.

2 Garage structure set back from main building line. Height to be no higher than the ground floor heights.

3 Boundary hedges to screen vehicles and parking spaces.

Figure 33: On-plot garage layout. (left) Illustrative diagram showing an indicative layout of on-plot parking with garages. (right) Indicative layout of a garage with cycle storage area.

Bicycle parking and storage

The use of alternative modes of transport such as walking and cycling should be encouraged and supported with appropriate facilities. Therefore, all new developments should provide a safe and convenient cycle storage/parking in new homes and employment sites. Some design guidelines for new development are:

- i. Cycle storage must be provided at a convenient location with easy access;
- ii. The storage space must be designed for flexible use and should be well integrated into the streetscape if it is allocated at the front of the house;
- iii. New residential developments must provide secured covered cycle parking and publicly available cycle parking in the public realm;
- iv. The use of planting and smaller trees alongside cycle parking can be used to mitigate any visual impact on adjacent spaces or buildings;
- v. Visitor cycle parking within residential areas must be provided close to the buildings in the form of a suitable stand or wall bar; and
- vi. Bicycle stands in the public realm should be sited in locations that are convenient and that benefit from adequate natural surveillance. They should be placed in locations that do not impede pedestrian mobility or kerbside activities.



Figure 34: Example of enclosed cycle storage.



Figure 35: Example of a communal cycle parking in a residential scheme, UK.



Figure 36: Example of a communal cycle parking in a residential scheme, UK.

DC.2.3 Legibility and wayfinding

A legible and well signposted place is easier for people to understand as they can better orient themselves using landmarks and visual clues in the townscape. Being able to understand how a place fits together and knowing how to negotiate your way through it more easily makes for a more pleasant experience, as well as helping people to feel safer and more connected with their environment.

There are already a number of elements within the town that help people to locate themselves, including landmark buildings, specimen trees and smaller elements such as signs or unique bits of street furniture. Where these features exist, they should be protected; while new development should seek to use the same mix of elements to create clear visual links and establish a clear hierarchy and relationship between different spaces. Some design guidelines for new development are:

- i. Wayfinding must be clearly established throughout the town and should be designed to complement and not clutter the public realm;
- ii. New development should be designed and laid out in a manner that facilitates intuitive orientation and navigation, through appropriate uses of vistas and memorable features;
- iii. A familiar and recognisable environment makes it easier for people to find their way around.

Obvious and unambiguous features should be designed in new development;

- iv. Buildings which are located at corners, crossroads or along a main road could play a significant role in navigation;
- v. At a local level, landmark elements could be a distinctive house, public art, or even an old and sizeable tree;
- vi. Elements like new signage design should be easy to read. Languages, fonts, text sizes, colours and symbols should be clear and concise, and avoid confusion;
- vii. Signage can promote existing and newly proposed footpaths and cycle lanes, encouraging people to use them more;
- viii. Signage should be strategically located to highlight gateways and access points, creating connections with important places and destinations; and
- ix. Signage elements and techniques should be appropriate to the character of the area and be a nice fit to the existing architectural style and details.



Figure 37: The old station located in the corner of the Maryland and Polka Road is a building of historic importance and acts as a landmark for pedestrians and drivers.



Figure 38: Open spaces within the town, like Buttlands, can act as landmarks and help legibility in the town.

DC.3 Relationship with the street and other spaces

DC.3.1 Overlooking the public space

Designing out crime and designing in community safety is essential to the creation of successful, safe and attractive developments.

The following guidelines are in line with the latest manual endorsed by the police 'Secured by Design Homes 2019'. The guidelines for new development are:

- i. There should be well-defined routes, spaces and entrances that provide convenient movement without compromising security;

- ii. Main building façades should overlook the open spaces to improve natural surveillance. In addition, side windows and driveways should also be well-overlooked;
- iii. Integrate facilities into the open spaces that meet the needs of the people living close by in order to make them attractive;
- iv. Avoid using too much green screening on the front gardens in order to allow for some views to the street and the open spaces; and
- v. Integrate light installations along the streets as well as in the open spaces in order to improve the feeling of safety in the area.



Figure 39: Local example of buildings overlooking the streets creating active frontages and opportunities for socialising with neighbours.



Figure 40: Example of a recent development in the town where there is a variation in the building rotations, whilst the majority of the buildings are facing the open green space.



Figure 41: Local example of buildings overlooking a public green space offering nice views to the residents and a sense of natural surveillance.



Figure 42: Local example of physical boundary treatment in the front gardens which also allows for clear views to the street ensuring a level of natural surveillance.

DC.3.2 People-friendly streets

- i. Streets must meet the technical highways requirements as well as being considered a 'place' to be used by all, not just motor vehicles. It is essential that the design of new development should include streets and junctions that incorporate the needs of pedestrians, cyclists, and if applicable, public transport users. It is also important that on-street parking, where introduced, does not impede the access of pedestrians and other vehicles;
- ii. Within the settlement boundaries, streets should not be built to maximise vehicle speed or capacity. Streets and junctions must be designed with the safety and accessibility of vulnerable groups such as children and wheelchair users in mind, and may introduce a range of traffic calming measures;
- iii. New streets should generally be linear with gentle meandering, providing interest and evolving views while helping with orientation;
- iv. Streets must incorporate opportunities for landscaping, green infrastructure, and sustainable drainage;
- v. Where appropriate, cycle paths should be incorporated into street design to encourage people to use alternative transport;

- vi. Crossing points that are safe, convenient, and accessible for pedestrians of all abilities must be placed at frequent intervals on pedestrian desire lines and at key nodes;
- vii. Along low-traffic lanes and residential streets, crossing points can be more informal. For example, pedestrians may cross at any section of a street whose surface is shared between different users;
- viii. Junctions must enable good visibility between vehicles and pedestrians. For this purpose, street furniture, planting, and parked cars must be kept away from visibility splays to avoid obstructing sight lines; and
- ix. Sufficient width of footway should be provided to facilitate a variety of mobilities, such as young families with buggies, mobility scooters, wheelchairs, etc. The Department for Transport Manual for Streets (2007) states there is no maximum width for a footway, it suggests that in lightly used streets, the minimum unobstructed width for pedestrians should generally be 2 m.

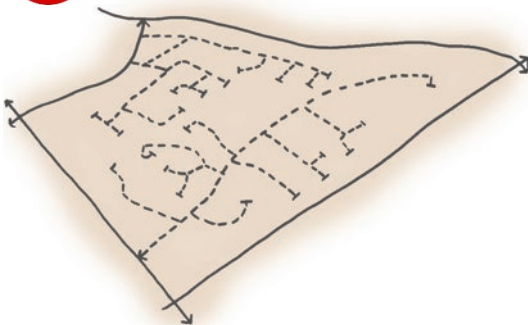

Figure 43: A layout dominated by cul-de-sacs encourages reliance on the car for even local journeys.



Figure 44: A connected layout, with some cul-de-sacs, balances sustainability and security aims in a walkable neighbourhood.

DC.3.3 Street planting

New street planting helps maintain visual consistency along the public realm. It is associated with better mental health and well-being by reducing stress, lessening heat islands, and providing protection from natural elements such as wind and rain. Some guidelines for new development are:

- i. Flower beds, bushes and shrubs should be welcomed in new developments, since they contribute to the liveliness of the streetscape. Normally planted within the curtilage boundary, ornamental species add interest and colour to their surroundings and become an identity and expressive feature of each dwelling;
- ii. Hedgerows can be planted in front of bare boundary walls to ease their visual presence or they can be used to conceal on-plot car parking and driveways within curtilages;
- iii. Trees can normally be used to mark reference points and as feature elements in the streetscape. When planted in intersections and key locations they can help with privacy whilst enhancing the wayfinding and distinctiveness of the area. These tend to be within property curtilages;

- iv. Trees should also be present in any public open space, green or play area to generate environmental and wildlife benefits;
- v. Retained trees should be considered at the earliest design stage to ensure that any retained trees will be able to grow and mature in the future without outgrowing their surroundings; and
- vi. The success of tree planting is more likely to be achieved when it has been carefully planned to work in conjunction with all parts of the new development, parking, buildings, street lights etc.



Figure 45: Local examples of street planting and vegetation.

DC.3.4 Street lighting

For maximum benefit, the best use of artificial light is about getting the right light, in the right place and providing light at the right time. Lighting schemes can be costly and difficult to change, so getting the design right and setting appropriate conditions at the design stage is important. Some guidelines for new development are:

- i. New development shall avoid the use of lighting, (e.g. blue LED light) that has a negative impact on health and wellbeing. In addition, the use of coloured red and green lights should be diminished to mitigate any negative impact on safe navigation into the harbour at night;
- ii. New development must consider lighting schemes that could be turned off when not needed. This could help mitigate any unacceptable levels of light pollution;
- iii. The needs of particular individuals or groups should be considered where appropriate (e.g. the safety of pedestrians, cyclists, drivers or older users); and
- iv. Vegetation and planting on front gardens should be dense to absorb light and also offer some separation between public and private space.



Figure 46: Local examples of street lighting with appropriate distance from the dwellings in order to avoid causing disturbance to the residents and light pollution.

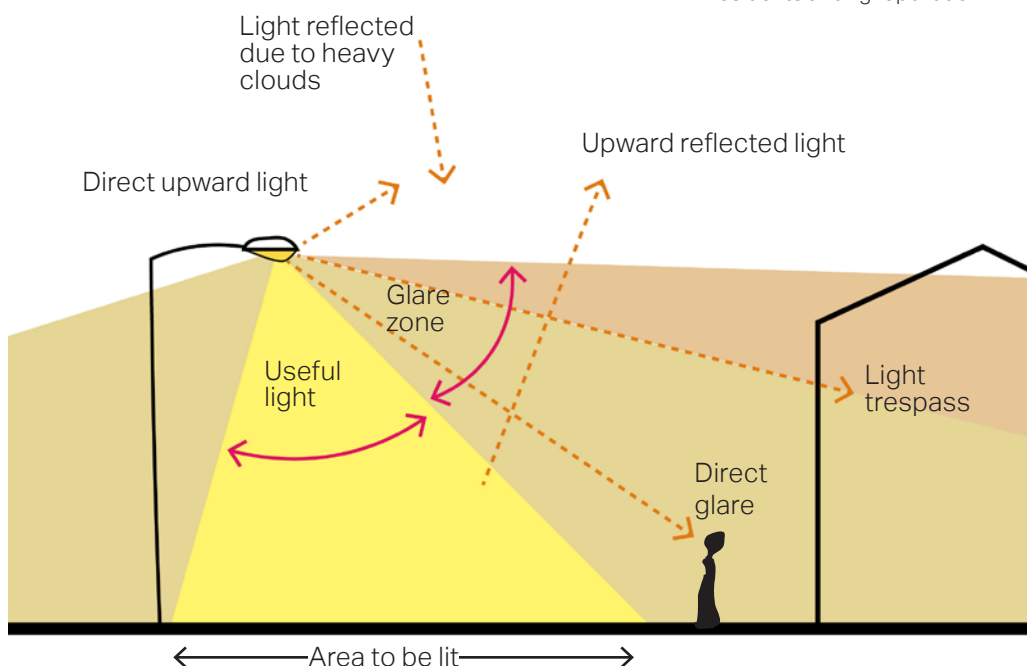

Figure 47: Diagram to illustrate the different components of light pollution and what 'good' lighting means.

DC.3.5 Enclosure

Focal points and public spaces in new development should be designed in good proportions and delineated with clarity. Clearly defined spaces help create an appropriate sense of enclosure - the relationship between a given space (lane, street, square) and the vertical boundary elements at its edges (buildings, walls, trees). The following principles serve as general guidelines that should be considered for achieving a satisfactory sense of enclosure in future development:

- i. When designing building setbacks, there must be an appropriate ratio between the width of the street and the height of the buildings;
- ii. Buildings should be designed to turn corners and create attractive start and end points of a new street or frontage;

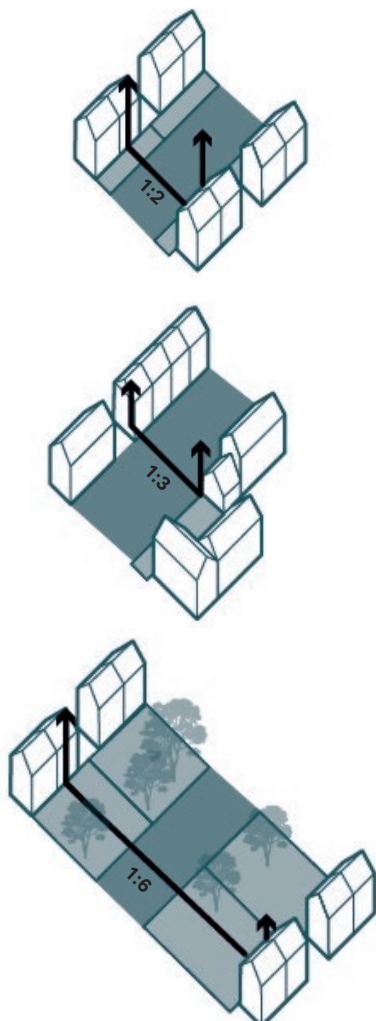

Figure 48: The various enclosure ratio depends on the amount of front garden width, road width, tree canopies and building heights.

- iii. Generally, building façades should front onto streets. Variation to the building line can be introduced to create an informal character;
- iv. In the case of terraced and adjoining buildings, it is strongly recommended that a variety of plot widths, land use, building heights, and façade depth should be considered during the design process to create an attractive streetscape and break the monotony of the street wall; and
- v. Trees, hedges, and other landscaping features can help create a more enclosed streetscape in addition to providing shading and protection from heat, wind, and rain.



Figure 49: Rich vegetation and large street trees can have an impact on the sense of enclosure on the streetscene.



Figure 50: Narrow streets and alleyways combined with terraced housing with limited gaps between buildings can create a sense of enclosure (1:2).

DC.3.6 Corner treatment

An important townscape principle is for buildings to satisfactorily address the corner. Where corner sites are visually prominent buildings should define the corner architecturally. Some guidelines for future development are:

- i. Buildings should have multiple entrances if possible and two active frontages should be created by incorporating prominent entrances and windows;
- ii. On corners which are less visually prominent, such as within the lower density residential areas, continuous built frontage should address the corner by using a series of linked dwellings where possible; and

- iii. When a terraced, detached or semi-detached house faces out onto the corner, the buildings should have the main entrance and habitable room windows facing both sides to create activity, and should overlook the street. This building can also be taller or have a distinctive architectural element to ensure a greater presence.

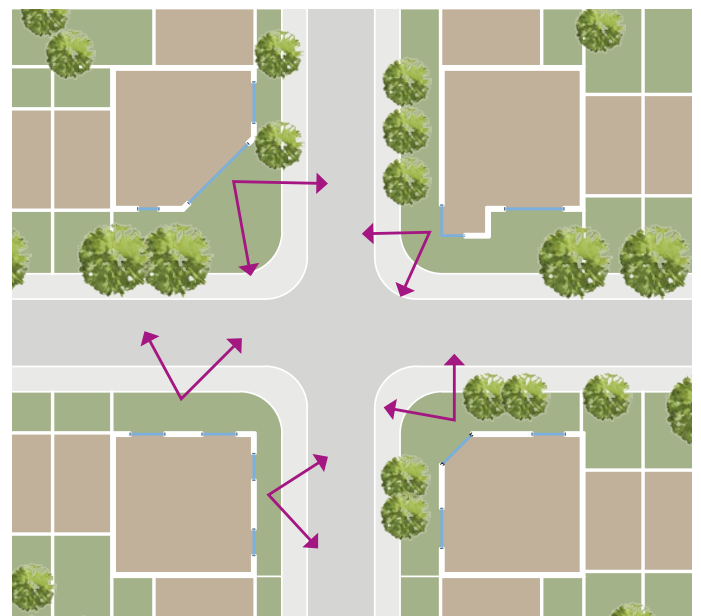

Figure 51: Diagram reflecting design principles for corner buildings.



Figure 52: Examples of corner buildings within the town with both facades active maximising natural surveillance and sun light.

DC.4 Shop fronts

DC.4.1 Signage

- i. The fascia is the most important area of a shopfront for advertising the business. Signage should be located within the established proportions and confines of the fascia board. Large box signs or additional flat boards should be avoided as they create disproportionate depth and height;
- ii. The most appropriate signage at fascia level is individual letters applied or painted directly onto the fascia board;
- iii. Hanging signs should be appropriately sized in relation to the building and street. They should not dominate the pavement space. They should use an appropriate material, shape, and form avoiding large box signs and they should not be illuminated. In particular, no hanging signage should be permitted on High Street or Staithe Street;
- iv. Hanging signs should be held by slender, well-designed brackets using a high quality material; and
- v. In the case of corporate brands, those should be sensitive to the existing context, size and scale and use materials and textures from the local vernacular of the area.

- ii. Conceal alarms from the shop front facade and integrate them discreetly within the shop front design or to the side of a building.



Character & Design

Integrate the shop front with the surrounding streetscape. Consider adjacent buildings and typical details in the area

Incorporate the overall proportion, form, and scale of the building's upper floors into the design of the shop front

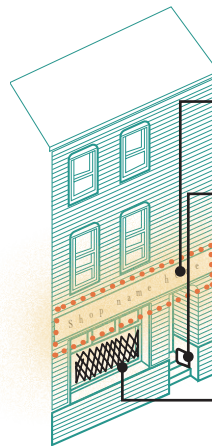

Lighting & Safety

Avoid using internally-illuminated box signs

Conceal alarms from the shop front facade and integrate them in the design

Avoid using external roller shutters and grilles. Favour the use of internal open grilles which cover only the glazed part of the shop front

DC.4.2 Lighting

- i. Avoid using visually distinct sources of illumination that result in disproportionate signage, such as internally-illuminated box signs.

DC.4.3 Safety

- i. Avoid using external roller shutters and grilles. Favour the use of internal open grilles which cover only the glazed part of the shop front; and

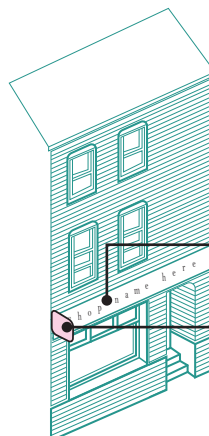

Signage

Avoid unnecessary visual clutter

Signage should not be placed on upper floors

Use the fascia as the predominant position for signage

Hanging signs should be in proportion to the building and street and should not dominate pavements

DC.4.4 Good examples of shop front design

Stall riser

- i. A stall riser should be incorporated into the design for the full width of the shopfront, except for the door opening. The height of the stall riser should be between 0.3m and 1m.

Materials

- ii. Window frames, doors, pilasters and fascias should be of timber construction with a painted finish and not a stained finish.

Panelling

- iii. Any timber panelling used in doors, stall risers, pilasters or other elements of the shop front should comprise a constructional timber panel and should not comprise the application of timber beading to a flat timber surface.

Fascia

- iv. The shop front design should include a full-width projecting fascia. The fascia should consist of a surrounding frame, creating an area for a shop-sign. Fascia with lettering of between 250mm and 300mm will read well from street level and from across the road; the size of the fascia is defined by the building typology or detailing, the font size should be proportionate to the fascia.

Lighting

- v. If lighting is incorporated into the design of the shop front, then it should comprise projecting light to create external illumination of the shop sign area.

Shutters

- vi. If shutters and shutter boxes are incorporated into the design, then they should be placed internally, behind the shop front. When in an open position, shutters should not block the shop window opening; and
- vii. Flood defences for houses and shops should remain in place only as long as flood warnings are in place/force.



Figure 53: Local examples of good shop front design.

DC.4.5 Shop front design next to the sea

There is some commercial activity towards the northern boundary of Character area 8, at the end of Beach Road. In particular, there are three buildings, a clothing shop, a cafe and an office-entrance to the car park.

It is important that any development in close proximity to the sea, the woodland and Norfolk Coastal path is limited and also remains sensitive to the surrounding architectural style and context. Therefore, some design guidelines for shop front design next to the sea are:

- i. Single story buildings should be proposed to fit nicely to the existing scale. Any development of more than one storey must be avoided;
- ii. Existing density should be respected and any new development should offer generous gaps between buildings to allow for views to the surrounding woodland and the sea;

- iii. Building facades should be dressed with weatherboarding, painted in off-white or light blue colour. Off-white rendered facades are also recommended;
- iv. Gable roofs are suggested, using Norfolk pantiles. In addition, overhanging roofs supported by timber frames could also be part of the design creating welcoming entrance points and offering some shading to the people; and
- v. Any surface along the shop fronts should be permeable and green features, like trees or grass are recommended.



Figure 54: Local examples of positive shop fronts next to the sea with similar architectural style and a colour palette that fits nicely to the surrounding natural environment.

DC.5 Development affecting heritage assets

There are several elements of historic significance in Wells-next-the-Sea which make a positive contribution to the character of the area. In particular, the grade II and II* listed buildings, mainly located within the conservation area, which include historic landmarks like St Nicholas' Church, the Granary, the old Lifeboat Station on the Quay, the Old Railway Station, the former flour mill and the old water tower. Therefore, design guidelines should be in place to guide development in close proximity to heritage assets. Those guidelines are:

- i. Development which affects any designated and non-designated heritage asset must respect the significance of the asset and must demonstrate how local distinctiveness is reinforced;

- ii. Development should respect the significance of any designated and non-designated heritage assets. Particular consideration shall be given to maintaining their role in framing, punctuating or terminating key views through, or out of the town; and
- iii. Particular consideration shall be given to the retention of open spaces and gaps between buildings to sustain the historic form and pattern of development and the setting of heritage assets.



Figure 55: The old railway station.



Figure 56: Listed buildings within the town core area.



Figure 57: The Granary on the Quay.



Figure 58: St Nicholas' Church.

DC.6 Building scale and form

DC.6.1 Scale, form and massing

The scale, form and massing of buildings are important to the character of a place; therefore, the existing context needs to be considered and new development needs to react sensitively to preserve and enhance the best characteristics of a place ensuring a harmonious relationship with neighbouring buildings, spaces and streets. Across the town, the majority of the buildings are between two to two and a half storeys, down to single storey for cottages and bungalows. The Quay is the only exception with a number of buildings that reach up to five storeys in height. Some guidelines for future development are:

- i. Development within the town should be of a scale and design to reinforce the locally distinctive character of the area and shall be no more than two storeys high;
- ii. The scale and massing of new buildings should be in keeping with the form and massing of neighbouring properties and must have regard of their impact at street level and also to their appearance from more distant views; and
- iii. The height of new buildings should be in keeping with neighbouring properties and the design shall demonstrate how heights of development will not be over-bearing or dominant in the existing street scene and on the overall townscape.



Figure 59: Building heights and massing have subtle variations and are generally in keeping with neighbouring properties.

DC.6.2 Building lines and boundary treatments

Building line and boundary treatments vary across the town. To respect the existing context, both the building and the boundary features should be consistent with neighbouring properties while enabling enough variations for visual interest. Some design guidelines for future development are:

- i. Buildings should front onto streets. The building line should have subtle variations in the form of recesses and protrusions but should generally form a unified whole;
- ii. Buildings should be designed to ensure that streets and/or public spaces have good levels of natural surveillance from buildings. This can be ensured by placing ground floor habitable rooms and upper floor windows facing the street;

- iii. Natural boundary treatments should reinforce the sense of continuity of the building line and help define the street, appropriate to the character of the area. They should be mainly continuous hedges and low walls, as appropriate, made of traditional materials found elsewhere in the town such as local bricks. The use of either panel fencing or metal or concrete walls in these publicly visible boundaries should be avoided. Natural boundary treatments should still enable adequate natural surveillance; and
- iv. In the case of edge lanes, natural boundary treatments can act as buffer zones between the site and the countryside and offer a level of protection to the natural environment.



Figure 60: Examples of different types of boundary treatments and boundary lines within the town. A subtle variation in the vegetation and building lines creates a visual interest and offers aesthetic variety in the streetscape.

DC.6.3 Infill development and housing extensions

Infill development

There are several examples, both positive and negative, of infill development within the town. Therefore, some design guidelines for infill development would be useful to provide a design context that respects the adjacent properties and the local vernacular of the area.

- i. Infill development should complement the street scene into which it will be inserted. It needs to reflect the materials, scale, massing and layout of the surrounding properties, as shown in Figure 61.
- ii. The above elements also need to be considered in relation to topography, views, vistas and landmarks; and
- iii. New building lines should be reasonably consistent along a street with existing buildings.

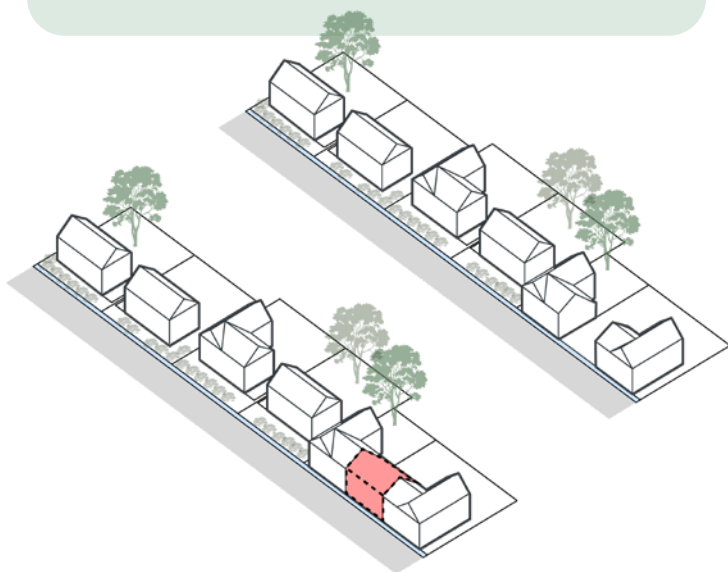

Figure 61: Indicative diagrams illustrating a site before and after infill.

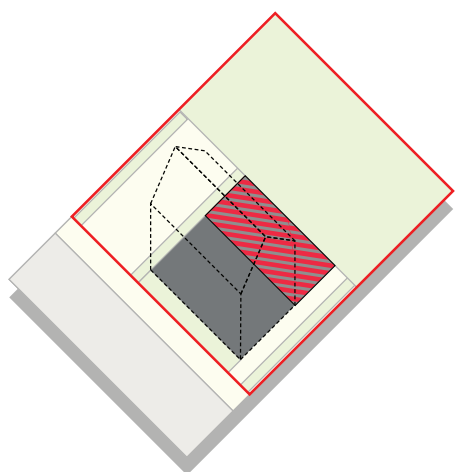

Figure 62: Diagram illustrating the basic principle about 50% coverage of the plot area for both the main building and annex.

Plot coverage

There is a trend in the town for small outbuildings to be erected in gardens, often for holiday accommodation. This can bring issues of amenity and also affect drainage and biodiversity. Plot area ratios can be used to inform appropriate development massing. Plot area ratio is the proportion of the site area occupied by buildings, calculated by dividing the gross ground floor area of the building by the plot area.

- iv. Residential development here should accord with existing precedent which is generally <0.5 . Higher densities may be appropriate in some areas owing to existing precedent, as shown in Figure 62.

Housing extensions

Extensions to dwellings can have a significant impact not only on the character and appearance of the building, but also on the street scene within which it sits. A well-designed extension can enhance the appearance of its street, whereas an unsympathetic extension can create problems for neighbouring residents and affect the overall character of the area. The Planning Portal¹ contains more detailed information on building modifications and extensions, setting out what is usually permitted without planning permission (permitted development) as well as what requires planning permission. Some guidelines for new development are:

- v. Extensions must be appropriate to the scale, massing and design of the main building and its adjacent buildings, and should complement the streetscape;
- vi. Alterations and extensions of historic buildings within a conservation area should preserve or enhance their character;
- vii. Extensions are more likely to be successful if they do not exceed the height of the original or adjacent buildings. Two-storey extensions, where appropriate, should be constructed with a pitch sympathetic to that of the existing roof;
- viii. The design, materials and architectural detailing of extensions should be high-quality and respond to the host building and local character;
- ix. The impact on the space and other buildings around the building should avoid overlooking, overshadowing or overbearing. In particular, overusing the plot size should be avoided.

1. Planning Portal. https://www.planningportal.co.uk/info/200234/home-improvement_projects

Side extension

Side extension is one popular way to extend a building to create extra living space. However, one effect is to reduce the number of smaller houses in the town, thus reducing affordability. Some design guidelines on side extensions are:

- x. Side extensions should not detract from the appearance of the building, its surroundings and the wider townscape;
- xi. Single-storey and double storey side extensions should be set back from the main building and complement the materials and detailing of the original building;
- xii. The roof of the extension should harmonise with that of the original building; flat roofs should be avoided; and
- xiii. Side windows should also be avoided unless it can be demonstrated that they would not result in overlooking of neighbouring properties.

Rear extension

Single storey rear extension is generally the easiest way to extend a house and provide extra living space. The effect of the reduction in the smaller houses applied here too. Some design guidelines on rear extensions are:

- xiv. The extension should be set below any first-floor windows and designed to minimise any effects of neighbouring properties, such as blocking day light;
- xv. A flat roof is generally acceptable for a single storey rear extension; and
- xvi. Double storey rear extensions are not common as they usually affect neighbours' access to light and amenity, however, sometimes the size and style of the property allows for a two-storey extension. In these cases, the roof form and pitch should reflect the original building and sit slightly lower than the main ridge of the building.

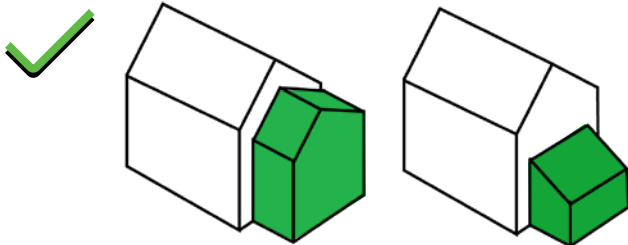

Good examples for side extensions, respecting existing building scale, massing and building line.

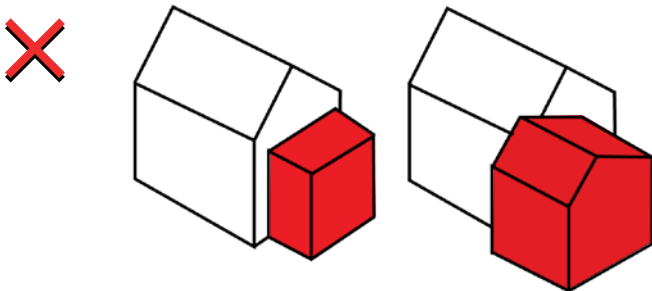

Both extensions present a negative approach when considering how it fits to the existing buildings. Major issues regarding roofline and building line.

DC.6.4 Density

Housing density is measured by the number of dwellings per hectare. The concept of density is important to planning and design as it affects the vitality and viability of the place. There is a variety of housing densities within Wells town ranging from high, within the town centre, to lower, when it gets closer to the open fields.

Therefore, some guidelines for new development are needed to ensure that the existing housing density numbers are respected.

- i. Density should be appropriate to the location of any new development and its surroundings and enhance the character of the existing settlement;
- ii. For larger development proposals a range of densities should be proposed to allow for variety in building types and forms. This creates a visual interest as well as meeting the needs of a wider group of people;
- iii. Higher densities could be proposed around key movement intersections and along strategic routes to signalise their importance and improve legibility. In addition, higher densities can support the viability of local services and facilities;
- iv. Pedestrian movement should be a priority and taken into account in larger development schemes. Housing density should support a 'human scale' development;
- v. In the case of perimeter blocks, which are highly encouraged, their size should be large enough to fit adequate amenity space and parking, yet small enough to allow a permeable and walkable patterns;
- vi. Housing densities should be reduced towards settlement edges and along rural edges in order to create a gradual transition between town and countryside.
- vii. Small scale development and in-fills are encouraged, because they follow the scale and pattern of existing grain and streets and therefore, retain the character of the area.



Figure 63: The town centre is characterised by high housing density in comparison to other locations in the town, Wells-next-the-Sea.



Figure 64: Northfield Estate is an example of a lower housing density within the town.

02/09/2021

	Density					
	2. Small Development (1-9 Units)	3. Medium Development (10-49 Units)	4. Large Development (50-100 Units)	5. Urban Extension or Neighbourhood (Over 100 Units)		
Typology	Scattered Dwellings	Village Fringe	Village Centre	Urban Fringe	Urban Centre	Typology
Density (du/ha)	1-2	10-30	15-35	20-40	30-50	Density (du/ha)
Height & Scale	Detached 1-2 storey	Detached Semi-detached 1-2 storey	Detached Semi-detached Terrace 1/2 storey	Detached Semi-detached Terrace 1/2/3 storey	Semi-detached Terrace 1/2/3 storey	Height & Scale
Separation (m)	21m back to back	21m back to back	21m back to back	21m back to back	15m back to back	Separation (m)
Street Types	Tracks/Lanes	Lanes, Mews, Informal Street	Mews, Suburban Street	Suburban Street, Shared Surfaces	Avenues, Shared Spaces, Urban Streets	Street Types
Form & Structure	Isolated rural forms	Irregular form, loose grain, less compact	Regular form, loose grain, street pattern	Variation in form, finer grain	Compact, regular form, fine grain	Form & Structure
Massing & Grouping	Open	Frequent breaks, landscaped edges	Regular breaks, soft edges	Some breaks, soft edges	Strong lines, clear groups	Massing & Grouping
External Curtilage	Soft boundary	Landscape buffer	Reflect prevailing character	Variety of soft & hard	Reflect prevailing character	External Curtilage
Parking	On plot	On plot	On street, on plot, courtyard	On plot, courtyard	On street, on plot, courtyard	Parking
Grain Figure Ground						Grain Figure Ground

Figure 65: The residential development framework developed by North Norfolk District Council sets out approximate densities for the relevant identified types. (Source: <https://designguide.north-norfolk.gov.uk/sections/residential-development/density/>).

DC.6.5 Building conversions

Retention and reuse of existing buildings is a sustainable option, in that it retains embodied energy/carbon and minimises the use of new resources.

The conversion or adaptation of existing vacant or redundant buildings is encouraged, particularly where they make a significant contribution to the wider townscape and the character of the area. Some guidelines are:

- i. Proposals for the conversion of existing property should be sympathetic to the building and propose an appropriate reuse/adaptation of the asset;
- ii. The architectural character and scale of the building should be carefully considered, and traditional materials and simple detailing employed when converting existing buildings;

- iii. Existing window and door openings should be retained and reused, and the number of new openings kept to a minimum. This is particularly important in the case of farm buildings to ensure that their agricultural character is retained;
- iv. Proposals that imitate historic architectural styles, using cheaper modern materials and demonstrating a lack of attention to detail as to the character and form of historic buildings within the settlement (including matters such as materials, proportion, massing, fenestration, rooflines/detailing, etc.), will be resisted; and
- v. Conversion of existing garages must not result in a reduction in existing on-site parking.



Figure 66: Positive examples of building conversions within the town that are sensitive to the surrounding context.

DC.6.6 Roofline

Creating a good variety in the roof line is a significant element of designing attractive places. There are certain elements that serve as guidelines in achieving a good variety of roofs:

- i. Roofline should be well articulated and in proportion with the dimensions of the building with subtle changes in the roofline to avoid monotonous elevations and avoid bulky, featureless appearance;
- ii. The scale of the roof should always be in proportion with the dimensions of the building itself;
- iii. Monotonous repetitions of the same building elevations should be avoided, therefore subtle changes in roofline should be ensured during the design process;

- iv. Traditional local roof materials, shapes, and detailing should be considered and implemented where possible in cases of new development; and
- v. Dormer windows must not be allowed to distort the overall look of the building or those adjoining and should not be inserted out of context. Where inserted they should be proportional to the dimensions of the roof and the design should be coordinated with the materials and architectural style used on the rest of the elevation.



Figure 67: The average building height within the town is between 2-2.5 storeys. The subtle variation in the eaves and ridge levels create a harmonious roofline that is well integrated with the vegetation and countryside in the background.

DC.7 Architectural styles, materials and details

DC.7.1 Architectural style

Wells-next-the-Sea has a rich vernacular architecture which constitutes its distinctive character and identity. There is a rich heritage of historic buildings, both of residential and industrial use, with various architectural styles such as cottages, Victorian villas, Georgian town houses. Terraced housing is a distinct characteristic of the historic town centre which allows for continuous façades along the narrow streets.

The photos presented on the next pages are a showcase of architectural styles, details and materials found in the town. In general some design guidelines for new development are:

- i. New development should use materials and architectural detailing that contributes to the historic and vernacular character of the area. It is important that the materials used in proposed development are of a high quality and reinforce local distinctiveness;
- ii. New development should demonstrate that the palette of materials has been selected based on a solid knowledge of the local vernacular style and traditions;
- iii. New development should reflect an intelligent understanding of the building details of the historic settlement cores without resulting in low-quality imitations of past styles; and
- iv. Any affordable housing development should be of high-quality and be indistinguishable from, and peppered amongst, other houses.



Figure 68: There are many industrial buildings in the town, mainly to the east, that sit well with the surrounding residential neighbourhoods by reflecting a similar style and massing (e.g. red bricks, gabled roofs).



Figure 69: The old station, that is now used as pottery and bookshop, is a building of great historic significance with buffed red brick on the facade and sash windows which have been preserved over time.



Figure 70: The use of flint with some brickwork on the building facades and the walls is a characteristic of the town and this can be found mainly within its historic core.



Figure 71: A positive example of recent development that sits sensitively in the local context, Mill Road North.

DC.7.2 Materials and colour palette

There is a range of architectural styles used within the town for walls, roofscape and fenestration.

The predominant building material used in the town is red brick with some examples of grey and local yellow brick, flint and coloured rendering. There are a mixture of brick and flint walls to be found across the town. Most roofs use Norfolk pantiles or slate tiles.

Some design guidelines for new development are:

- i. Architectural design shall reflect high quality local design references in both the natural and built environment and reflect and reinforce local distinctiveness; and
- ii. Any future development proposals should demonstrate that the palette of materials has been selected based on an understanding of the surrounding built environment.

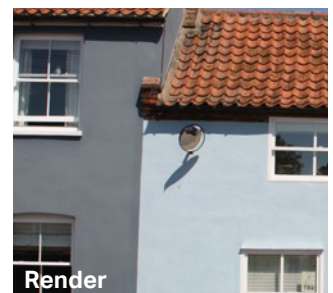
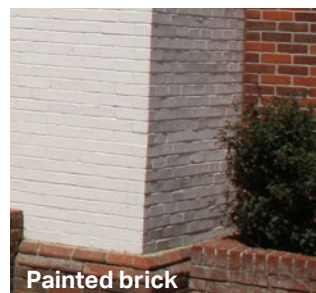
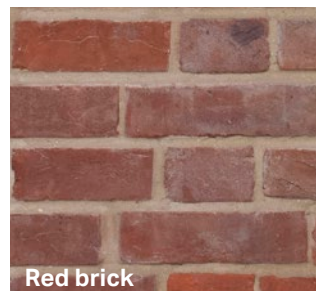

Figure 72: Positive local examples for wall materials in Wells-next-the-Sea.



Hipped roof with red pantiles



Gabled roof with red pantiles



Shed dormer



Norfolk pantiles



Timber painted window with yellow brickwork around



Sash window on a rendered wall



Bay window on a red brick wall



Sash window with brickwork



Flint with brickwork



Painted bricks in different colours



Off-white painted brick



Red brick



Timber clad facade



Porch



Decorated bargeboards and finial on the porch



Vegetation on the wall

DC.7.3 Building proportion

The relationships between the building and its elements can provide visual interest and enhance the local character. Some guidelines for future development are:

- i. The proportions of a building's elements should be related to each other as well as the scale and proportion of the building;
- ii. The proportions should be dictated by and respond to the type of activity proposed as well as the composition of the existing streetscape;
- iii. The front elevation of the buildings must be arranged in an orderly way to avoid creating cluttered facades; and
- iv. Features such as windows, doors and solid walls should create vertical and horizontal rhythms along the façade providing variety.

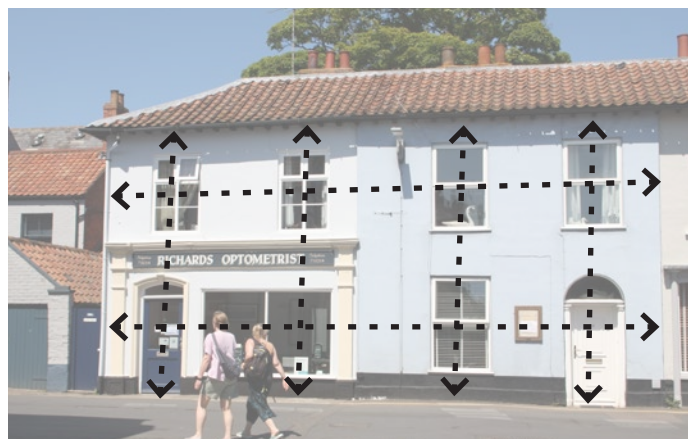
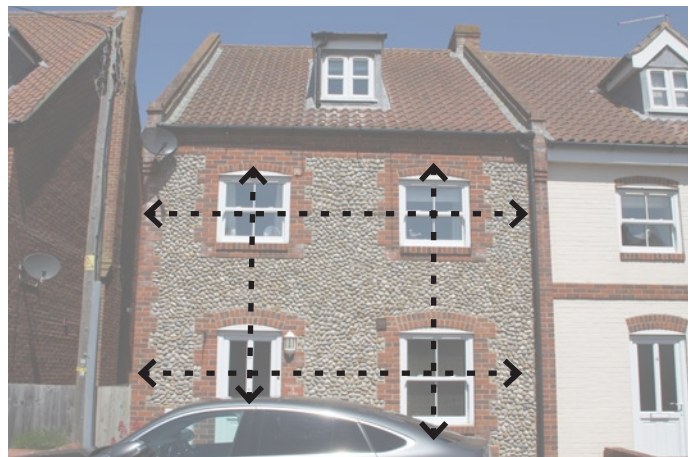
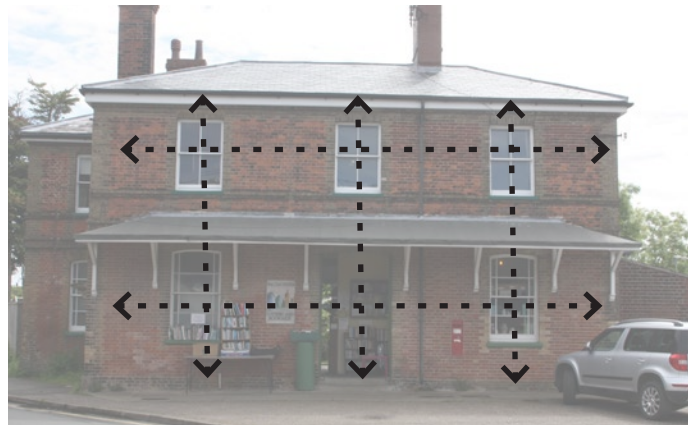

Figure 73: Local examples of consistent building proportions.

DC.7.4 Windows

The detailing, materials and fenestration of windows along building façades can inform the character of the street. Within the town, there are a variety of window styles with a predominance of casement and bay windows in older buildings that should be used as guidance for future windows in the town. Some guidelines for future development are:

- i. Windows should match the general orientation, proportion and alignment of other windows in the same building as well as those on adjacent properties, reinforcing the continuity of the streetscape;
- ii. The buildings in Wells often used to have small windows because of the desire to keep the weather out. Therefore, this characteristic needs to be preserved in new development and large panels of glass that are not subdivided should be avoided, unless they have a net-zero justification;

- iii. Windows in new developments should have consistent colour, thickness of frame and quality of windows across all elevations. Where PVC is used to replace other materials it should be of such character as to mimic the earlier design; and
- iv. Windows should employ a particular design approach by adopting either a contemporary or traditional style. Contemporary style buildings can have a variety of window designs whereas traditional building styles should have a limited range of patterns.



Figure 74: Examples of locally distinctive windows in the town.

DC.7.5 Doors

Different types of doors are used throughout the town creating an interesting and varied streetscape. Some guidelines for future development are:

- i. New development must use the existing architectural styles as inspiration in order for new doors to be in keeping with the town streetscape; and
- ii. Small porches and canopies at the entrance of buildings should be in keeping with the style and size of the house and should respect the building line of the street, particularly where a strongly defined building line is an important characteristic of a street. The roof pitch should match that of the original building to ensure it blends in with the building.

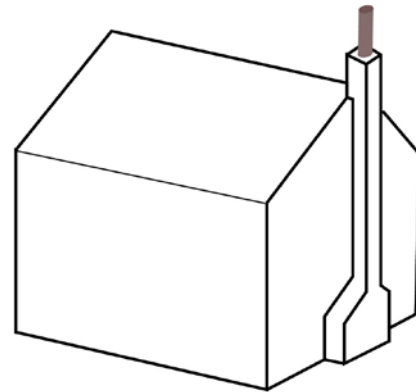

Figure 75: Examples of locally distinctive doors in the town.

DC.7.6 Chimneys

Chimneys can be seen across the town in all housing types, therefore, they can be placed in several locations. A modern approach should be taken to chimney design and chimneys should only be incorporated where they serve a function. In the case of small dwellings without fireplaces, gas fuel or soil and vent outlets can be combined into chimney structures. Some guidelines for future development are:

- i. Chimneys must match the primary elevation material and be placed symmetrically to the ridge line; and
- ii. Chimneys shall rise above the roof and when on an end elevation should connect to the ground. Chimneys should be positioned on the ridge of the roofs, centrally on a gable end or against an out-scale wall and should have pots.



Chimney connecting to the ground

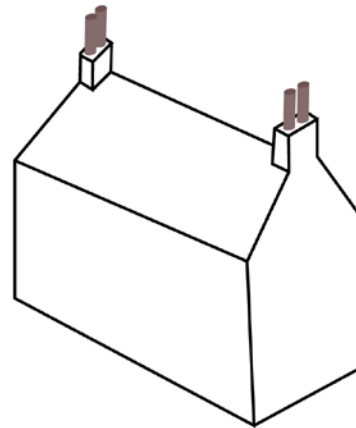

Symmetrical chimneys-directional emphasise suitable harmonious effect.

Figure 76: Examples of chimneys.



Figure 77: Examples of locally distinctive chimneys in the town. Some chimneys are integral to the building mass, while others sit outside and form projection.

DC.8 Open space

DC.8.1 Open space

There is limited open space within the fabric of Wells-next-the-Sea including Buttlands, the churchyard and the recent open space built as part of the new development to the west of Alderman Peel High School.

However, the presence of open space within and around an area can have a positive impact. If this is combined with mature trees, hedges and the surrounding landscape, then it contributes significantly to the improvement of the quality of the street scene. Therefore, some guidelines are:

- i. Open space should have a purpose and be of a size, location and form appropriate to the intended use, avoiding space left over after planning or pushing open space to the periphery of development;
- ii. Open spaces should be located within walking distance from their intended users, and if possible linked to form connected green networks. Where direct links are not possible, open spaces should be linked through green routes, shared surface and tree lined streets;

- iii. Public open spaces should be overlooked by surrounding buildings to promote natural surveillance and social gatherings;
- iv. New open spaces should not be used as a divisive measure between new and existing development, even though green buffer zones which distinguish between older and new development are acceptable;
- v. Open spaces should offer choices for the needs and desires of users of all ages and abilities. These include active sports, play spaces, communal gardens and quiet spaces. Play spaces should be accessible to all children and their design must consider seating areas for carers, shaded spaces and no hidden spots; and
- vi. Play areas should include elements relating to nature and landscape and the equipment and fittings employed should be of high quality, durability and conforming to the relevant standard.



Figure 78: The Buttlands is located in the centre of Wells; an open grassed area surrounded by mature lime trees which attracts many people and is often used for community events.



Figure 79: The open space located within the recent development to the southwest of the town includes play areas for families.

DC.8.2 Biodiversity and wildlife

Wells-next-the-Sea has a rich and varied landscape character. There are many natural features and assets, such as trees, hedges, front and back gardens, open spaces, recreational grounds, marshes, farmland. They all contribute to provide habitats for biodiversity to flourish. Therefore, any new development or any change to the built environment should:

- i. Seek to protect existing habitats and strengthen the biodiversity of the natural environment and net gain. In particular, development should enhance existing wildlife corridors that form the links between the urban and hinterland landscapes;
- ii. Preserve and protect the local wildlife and seek the creation of green corridors to benefit biodiversity;

- iii. Protect and enhance hedges, trees and road verges, where possible. Artificial grass is not encouraged;
- iv. Avoid abrupt edges to development with little vegetation or landscape on the edge of the settlement and, instead, aim for a comprehensive landscape buffering; and
- v. Employ boundary treatments to the side and rear of the property, which are permeable to wildlife. For example, native hedgerow, gapped wooden palisade or 'hit and miss' fencing with wildlife friendly gravel boards should be considered.



Figure 80: A swift brick



Figure 81: Example of a bug habitat decorating rear gardens or public green spaces



Figure 82: Public green open spaces can help enhance the wildlife.



Figure 83: Front and back gardens can play an important role in enhancing the wildlife.



Figure 84: Countryside and farmland can help enhance the wildlife.

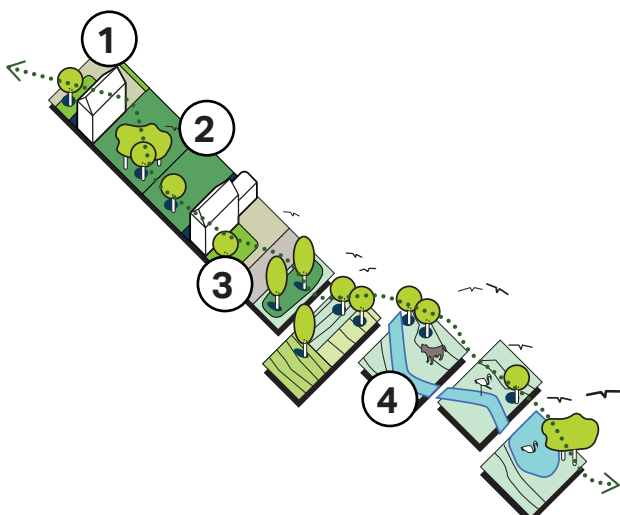

DC.9 Sustainable design

DC.9.1 Sustainable design

New developments should be designed for climate change mitigation and adaptation. Development proposals should consider layout, aspect, massing and use of materials in order to reduce energy consumption and thereby minimise contributions to climate change.

Historic buildings within the town can provide good examples of sustainable layouts and construction methods along with the efficient use of energy and local resources. Their survival reflects their success and adaptability.

There are opportunities in most historic buildings to improve energy conservation without causing harm, through measures such as secondary glazing, improved loft insulation using natural materials, low energy lighting and the use of fuel-efficient boilers. In some situations, renewable energy technologies can also be installed without causing harm to the heritage significance.

- i. The orientation of buildings within the plot, along with the site topography, must be considered to maximise solar gain while keeping a consistent frontage to the street;
- ii. Living spaces within each typology should be oriented according to the expected use of each room, e.g. sun in the morning for kitchens, during the day for living areas, and in the evening for bedrooms;
- iii. The design of new developments must maximise the use of energy efficiency and energy conservation fixtures, fittings and technology. Passive methods of heating and cooling and the use of renewable energy technologies such as ground source and air source heat pumps, biomass heating, photovoltaics and solar panels must be considered for new developments. Opportunities for the use of the same technologies in existing buildings, when undergoing refurbishment, will also be expected;

- iv. Appropriate materials and detailing should be considered to minimise heat loss. Direct entry from the street to an interior living space should be avoided where possible; and
- v. Solar access along the south façade should be maximised and openings on the north one minimised. Appropriate shading elements and cross ventilation should be employed in new and existing buildings.

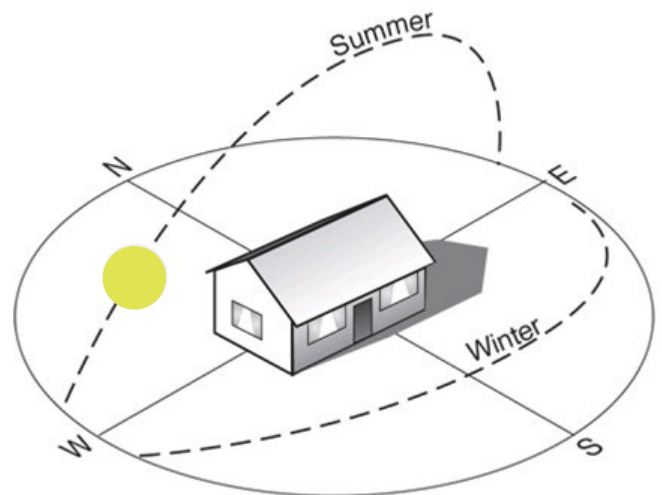

Figure 85: Illustration to show the appropriate building orientation so as to maximise solar gains. Windows should be placed mainly on the southern side whilst fewer openings should be located on the northern. A deep roof overhang can offer some shading. This can also be improved with some trees and vegetation around the house. (Source: <https://nextdayinspect.com/building-orientation-for-optimum-energy/>).

DC.9.2 Net-zero carbon

Energy efficient or eco design combines all-round energy efficient construction, appliances, and lighting with commercially available renewable energy systems, such as solar water heating and solar electricity.

Starting from the design stage, there are strategies that can be incorporated towards passive solar heating, cooling and energy efficient landscaping which are determined by local climate and site conditions. The retrofit of existing buildings with eco design solutions should also be encouraged.

The aim of these interventions is to reduce overall home energy use as cost effectively as the circumstances permit. The final step towards a high-performance building would consist of other on site measures towards renewable energy systems.







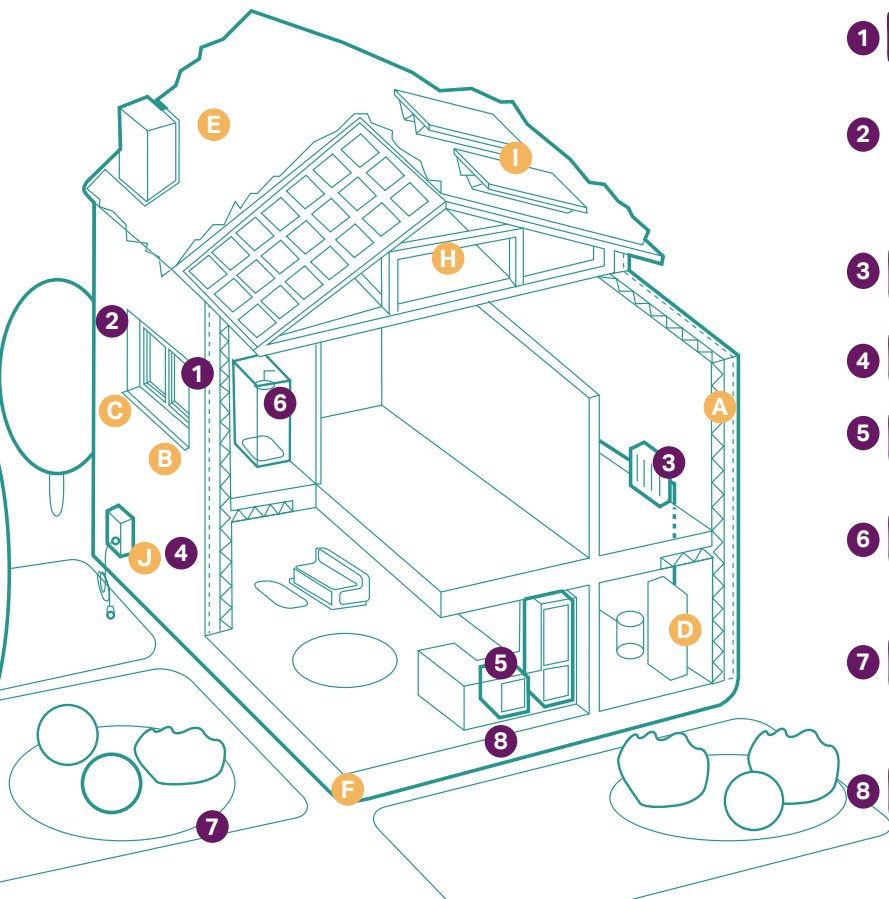

It must be noted that eco design principles do not prescribe a particular architectural style and can be adapted to fit a wide variety of built characters. A wide range of solutions is also available to retrofit existing buildings, included listed properties, to improve their energy efficiency¹.

1. Historic England. <https://historicengland.org.uk/advice/technical-advice/energy-efficiency-and-historic-buildings/>









- i. Buildings must be built with high levels of energy efficiency. Construction materials should be effectively reused, recycled and locally sourced. Material should be transported on site in the most sustainable manner and have low embodied energy. Energy efficient and water efficient technologies must be positively integrated; and
- ii. Buildings must achieve at least a minimum level of carbon reductions through a combination of energy efficiency, on-site energy supply and/or (where relevant) directly connected low carbon or renewable heat and choose from a range of (mainly off-site) solutions for tackling the remaining emissions.



Existing homes

- 1  **Insulation**
in lofts and walls (cavity and solid)
- 2  **Double or triple glazing with shading** (e.g. tinted window film, blinds, curtains and trees outside)
- 3  **Low- carbon heating** with heat pumps or connections to district heat network
- 4  **Draught proofing** of floors, walls, windows and doors
- 5  **Highly energy- efficient appliances** (e.g. A+++ and A+++ rating)
- 6  **Highly water- efficient devices** with low-flow showers and taps, insulated tanks and hot water thermostats
- 7  **Green space (e.g. gardens and trees)** to help reduce the risks and impacts of flooding and overheating
- 8  **Flood resilience and resistance** with removable air back covers, relocated appliances (e.g. installing washing machines upstairs), treated wooden floors

Additional measures in new build homes

- A  **High levels of airtightness**
- B  **More fresh air** with mechanical ventilation and heat recovery, and passive cooling
- C  **Triple glazed windows and external shading** especially on south and west faces
- D  **Low-carbon heating**
- E  **Water management and cooling** more ambitious water efficiency standards, green roofs and reflective walls
- F  **Flood resilience and resistance** e.g. raised electrical, concrete floors and greening your garden
- H  **Construction and site planning** timber frames, sustainable transport options (such as cycling)
- I  **Solar panels**
- J  **Electric car charging point**

DC.9.3 Solar roof panels

Solar panels (PV or hot water heating) can have a positive environmental impact. However, their design and installation needs careful consideration, particularly when carried out on historic buildings or within sensitive areas. Preservation of the character of the town is a priority, but there are numerous examples where technology has been designed to reflect and complement local vernacular and character.

A few principles relating to the sensitive installation of solar technology are set out below:

On new builds:

- i. Use the solar or PV panels as a material in their own right;
- ii. Adopt solar technology from first principles, embedding their use into the design concept from the very start. Some attractive options are solar shingles and photovoltaic slates;

- iii. Analyse the proportions of the building and roof surface in order to identify the best location and sizing of panels;
- iv. Consider introducing other tile or slate colours to create a composition with the solar panel materials;
- v. Conversely, aim to introduce contrast and boldness with proportion. There has been increased interest in black panels due to their more attractive appearance. Black solar panels with black mounting systems and frames can be an appealing alternative to blue panels; and
- vi. Carefully consider the location of solar panels on buildings within the historic part of Wells-next-the-Sea town. It might be appropriate to introduce solar panels to areas of the building that are more concealed in order to preserve the character and appearance of the town.



Figure 86: Integration of solar panels on the south-facing side of the roof of a new house in Lingfield, Surrey. The dark colour of the solar panels nicely matches with the dark brown tiles of the roof.



Figure 87: Use of shingle-like solar panels on a slate roof, with the design and colour of the solar panels matching those of the adjacent slate tiles in Lingfield, Surrey.

DC.9.4 Green and brown roofs

Green roofs improve drainage, add to biodiversity and, in some instances, can improve the thermal performance of the roof.

- i. Whether the roof is partially or completely covered with vegetation, its design should follow some basic principles such as, having been planned from the design stage; being easy to reach and maintain; being complementary (where applicable) to its immediate environment and helping to integrate the building with the surrounding landscape; and
- ii. Design comprehensively with other eco designs such as water harvesting and porous pavements.



Figure 88: Green elements can be integral to the roofs of storage rooms in the garden. In this way, those structures become part of the landscape and their presence is less apparent. (Source: <https://www.lowimpact.org/lowimpact-topic/living-roofs/>).



Figure 89: Green roof integrating the building with the surrounding landscape (Source: <https://earlyexperts.net/green-roofing-a-house-advantages-and-costs/>).

DC.9.5 Sustainable drainage systems

New developments should seek to reduce flood risk overall through creation of multi-functional green infrastructure and sustainable drainage systems. It is essential to demonstrate that the development will be safe and flood risk is not increased elsewhere.

It is important to change the traditional approach to managing flood risk to one of accepting water as a valuable resource whose benefits should be maximised within the design process.

New developments should consider the amenity and aesthetic value of surface water in the urban environment alongside long term environmental, biological and social factors in the context of climate change and urbanisation.

SuDS should be considered as a key design tool to achieve those wider goals and not a mere functional requirement.

- i. New and existing developments must capitalise on SuDS possibilities as a key design element to provide amenity and aesthetic value to the development.

SuDs definition

The term SuDS stands for Sustainable Drainage Systems. It covers a range of approaches to managing surface water in a more sustainable way to reduce flood risk and improve water quality whilst improving amenity benefits.

SuDS work by reducing the amount and rate at which surface water reaches the combined sewer system. Usually, the most sustainable option is collecting this water for reuse, for example, in a water butt or rainwater harvesting system, as this has the added benefit of reducing pressure on important water sources.

Where reuse is not possible there are two alternative approaches using SuDS:

- Infiltration, which allows water to percolate into the ground and eventually restore groundwater; and
- Attenuation and controlled release, which holds back the water and slowly releases it into the sewer network. Although the overall volume entering the sewer system is the same, the peak flow is reduced. This reduces the risk of sewers overflowing.

The most effective type or design of SuDS would depend on site-specific conditions such as underlying ground conditions, infiltration rate, slope, or presence of ground contamination. A number of overarching principles can however be applied:

- i. Manage surface water as close to where it originates as possible;
- i. Reduce runoff rates by facilitating infiltration into the ground or by providing attenuation that stores water to help slow its flow down so that it does not overwhelm water courses or the sewer network;
- i. Improve water quality by filtering pollutants to help avoid environmental contamination;
- i. Integrate into development and improve amenity through early consideration in the development process and good design practices;
- i. SuDS are often as important in areas that are not directly in an area of flood risk themselves, as they can help reduce downstream flood risk by storing water upstream; and
- i. Some of the most effective SuDS are vegetated, using natural processes to slow and clean the water whilst increasing the biodiversity value of the area.



Figure 90: Examples of SuDS designed as a public amenity and fully integrated into the design of the public realm, Sweden.

DC.9.6 Resilience to sea-level rise

Coastal areas, like Wells-next-the-Sea, face the challenge of increasing population compounded by an increased potential of flooding. In particular, flooding is increasingly becoming an issue across Norfolk and the county is known to be susceptible to rising sea levels and coastal erosion.

Therefore, building codes and design standards have an important role in making development resilient to predicted sea-level rise impacts through measures. Expert advice should be sought, but some guidelines for new developments in areas that may be particularly susceptible for flooding include:

- i. No habitable rooms at ground floor level;
- ii. Consider raising slab levels to provide ground floors with an element of free board relative to flood levels;
- iii. Avoid any development space in basements or semi-basements, and
- iv. Provide refuge spaces and safe means of escape from dwellings in a flood event.



Figure 91: Example of adaptive architecture where living spaces are raised to respond to potential flooding. For most of the year, it serves as a typical house and only in a flood does it transform to allow an alternative 'turned around' living arrangement to be adopted. (Source: <https://www.ice.org.uk/getattachment/media-and-policy/policy/facing-up-to-rising-sea-levels/Facing-Up-to-Rising-Sea-Levels-Document-Final.pdf.aspx>).

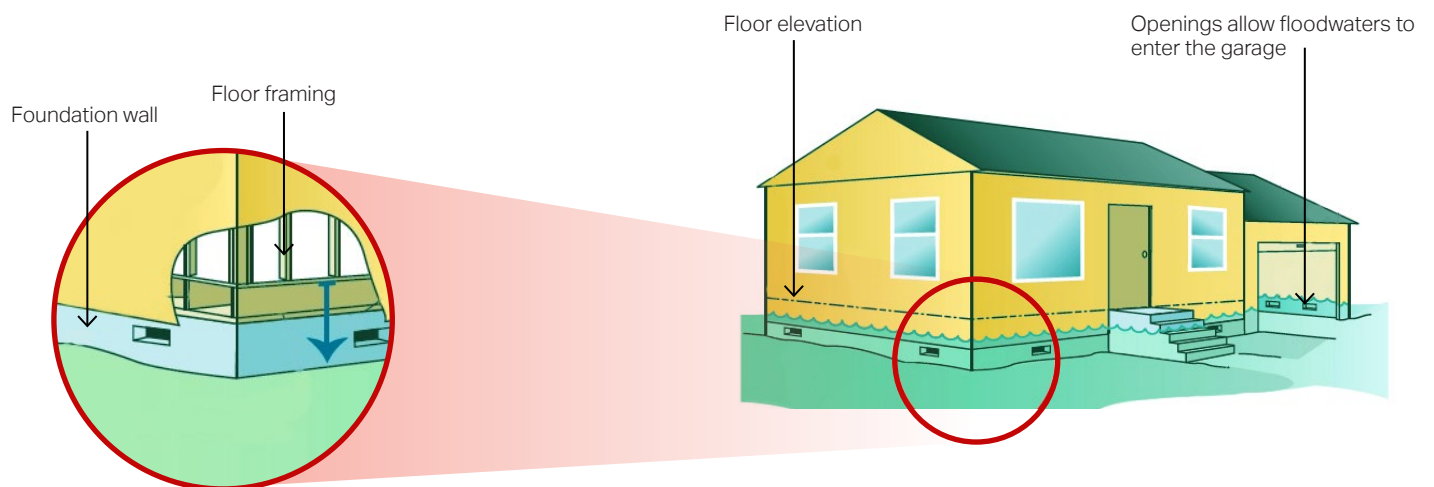

Figure 92: Diagram to illustrate some basic principles for building elevations.

DC.9.7 Storage and slow release

Rainwater harvesting refers to the systems allowing capture and storage of rainwater as well as those enabling the reuse in-situ of grey water. Simple storage solutions, such as water butts, can help provide significant attenuation. To be able to continue to provide benefits, there has to be some headroom within the storage solution. If water is not reused, a slow release valve allows water from the storage to trickle out, recreating capacity for future rainfall events. New digital technologies that predict rainfall events can enable stored water to be released when the sewer has greatest capacity to accept it.

These systems involve pipes and storage devices that could be unsightly if added without an integral vision for design. Therefore, some design recommendation would be to:

- i. Conceal tanks by cladding them in complementary materials;
- ii. Use attractive materials or finishing for pipes;
- iii. Combine landscape/planters with water capture systems;
- iv. Install underground tanks; and
- v. Utilise water bodies for storage.

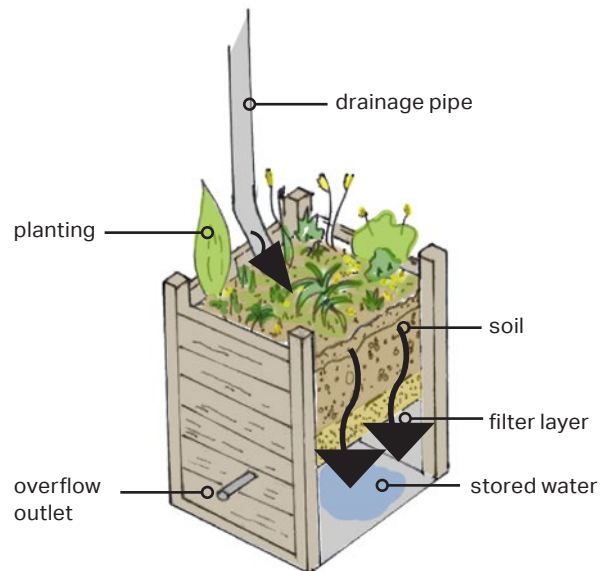

Figure 94: Diagram illustrating the functioning of a stormwater planter.

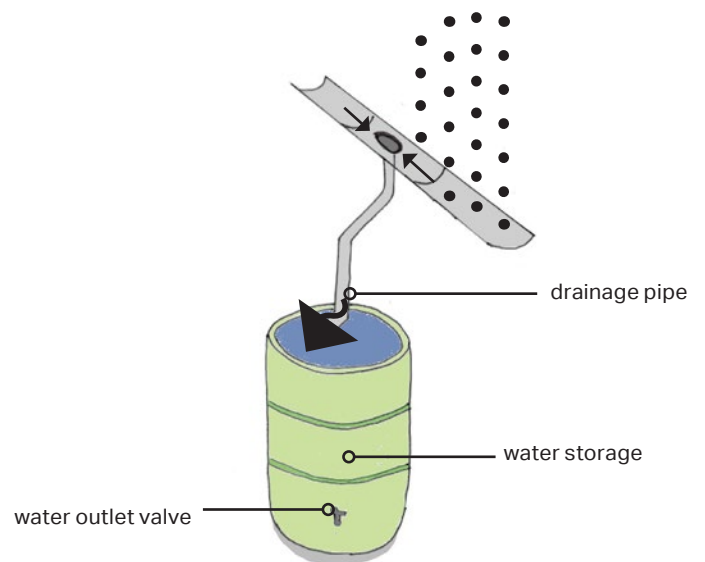

Figure 95: Diagram illustrating the functioning of a water butt.



Figure 93: Examples of water butts used for rainwater harvesting in Reach, Cambridgeshire.

DC.9.8 Permeable paving

Most built-up areas, including roads and driveways, increase impervious surfaces and reduce the capacity of the ground to absorb runoff water. This in turn increases the risks of surface water flooding. Permeable pavings offer a solution to maintain soil permeability while performing the function of conventional paving. The choice of permeable paving units must be made depending on the local context; the units may take the form of unbound gravel, clay pavers, or stone setts.

Permeable paving should be used where possible on footpaths, public squares, private access roads, driveways, and private areas within development boundaries. In addition, permeable pavement must also align with the following Acts:

- Flood and Water Management Act 2010, Schedule 3¹;
- The Building Regulations Part H – Drainage and Waste Disposal²; and
- Town and Country Planning (General Permitted Development) (England) Order 2015³.

1 Great Britain (2010). Flood and Water Management Act, Schedule 3. Available at: <http://www.legislation.gov.uk/ukpga/2010/29/schedule/3>

2 Great Britain (2010). The Building Regulations Part H – Drainage and Waste Disposal. Available at: https://assets.publishing.service.gov.uk/government/uploads/system/uploads/attachment_data/file/442889/BR_PDF_AD_H_2015.pdf

3 Great Britain (2015). Town and Country Planning (General Permitted Development) (England) Order 2015. Available at: http://www.legislation.gov.uk/uksi/2015/596/pdfs/uksi_20150596_en.pdf

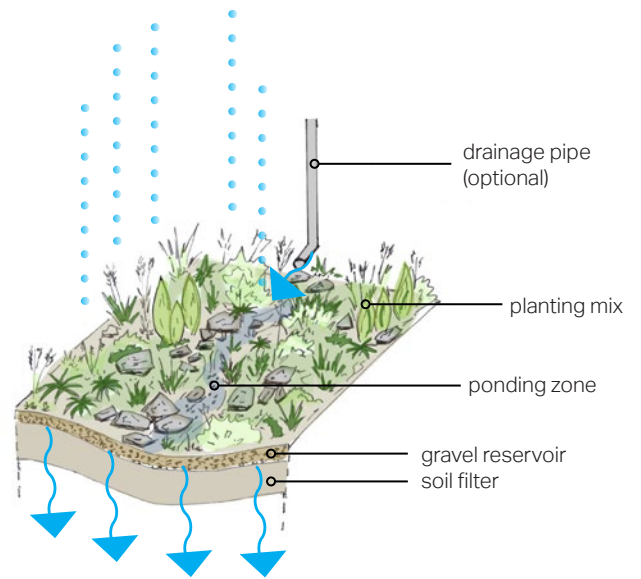

Figure 96: Diagram illustrating the functioning of a rain garden.

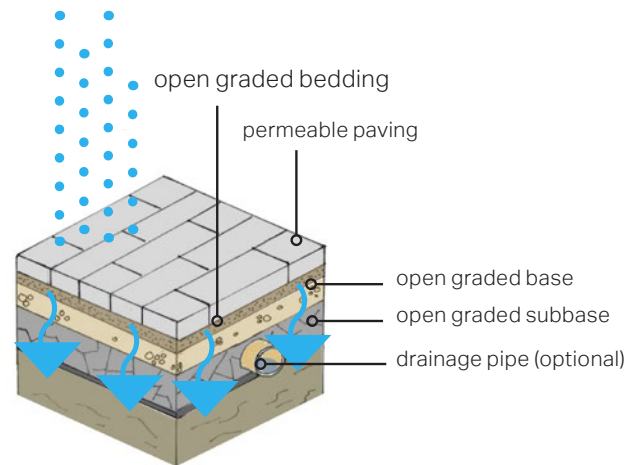

Figure 97: Diagram illustrating the functioning of a soak away.



Figure 98: Examples of permeable paving that can be used in the front and rear gardens of residential buildings.



04

Checklists

4. Checklists

Because the design guidance and codes in this document cannot cover all design eventualities, this chapter provides a number of questions based on established good practice against which the design proposal should be evaluated. The aim is to assess all proposals by objectively answering the questions below. Not all the questions will apply to every development. The relevant ones, however, should provide an assessment as to whether the design proposal has taken into account the context and provided an adequate design solution.

As a first step there are a number of ideas or principles that should be present in all proposals. These are listed under "General design guidance for new development." Following these ideas and principles, a number of questions are listed for more specific topics on the following pages.

1

General design guidance for new development:

- Integrate with existing paths, streets, circulation networks and patterns of activity;
- Reinforce or enhance the established settlement character of streets, greens, and other spaces;
- Harmonise and enhance existing settlement in terms of physical form, architecture and land use;
- Relate well to local topography and landscape features, including prominent ridge lines and long-distance views;
- Reflect, respect, and reinforce local architecture and historic distinctiveness;
- Retain and incorporate important existing features into the development;
- Respect surrounding buildings in terms of scale, height, form and massing;
- Adopt contextually appropriate materials and details;
- Provide adequate open space for the development in terms of both quantity and quality;
- Incorporate necessary services and drainage infrastructure without causing unacceptable harm to retained features;
- Ensure all components e.g. buildings, landscapes, access routes, parking and open space are well related to each other;
- Make sufficient provision for sustainable waste management (including facilities for kerbside collection, waste separation, and minimisation where appropriate) without adverse impact on the street scene, the local landscape or the amenities of neighbours;
- Positively integrate energy efficient technologies;
- Ensure that places are designed with management, maintenance and the upkeep of utilities in mind; and
- Seek to implement passive environmental design principles by, firstly, considering how the site layout can optimise beneficial solar gain and reduce energy demands (e.g. insulation), before specification of energy efficient building services and finally incorporate renewable energy sources.

2

Street grid and layout:

- Does it favour accessibility and connectivity? If not, why?
- Do the new points of access and street layout have regard for all users of the development; in particular pedestrians, cyclists and those with disabilities?
- What are the essential characteristics of the existing street pattern; are these reflected in the proposal?
- How will the new design or extension integrate with the existing street arrangement?
- Are the new points of access appropriate in terms of patterns of movement?
- Do the points of access conform to the statutory technical requirements?

3

Local green spaces, views and character:

- What are the particular characteristics of this area which have been taken into account in the design; i.e. what are the landscape qualities of the area?
- Does the proposal maintain or enhance any identified views or views in general?
- How does the proposal affect the trees on or adjacent to the site?
- Can trees be used to provide natural shading from unwanted solar gain? i.e. deciduous trees can limit solar gains in summer, while maximising them in winter.
- Has the proposal been considered within its wider physical context?
- Has the impact on the landscape quality of the area been taken into account?
- In rural locations, has the impact of the development on the tranquility of the area been fully considered?
- How does the proposal impact on existing views which are important to the area and how are these views incorporated in the design?
- Can any new views be created?
- Is there adequate amenity space for the development?
- Does the new development respect and enhance existing amenity space?
- Have opportunities for enhancing existing amenity spaces been explored?

3

Local green spaces, views and character:

- Will any communal amenity space be created? If so, how this will be used by the new owners and how will it be managed?
- Is there opportunity to increase the local area biodiversity?
- Can green space be used for natural flood prevention e.g. permeable landscaping, swales etc.?
- Can water bodies be used to provide evaporative cooling?
- Is there space to consider a ground source heat pump array, either horizontal ground loop or borehole (if excavation is required)?

5

Buildings layout and grouping:

- What are the typical groupings of buildings?
- How have the existing groupings been reflected in the proposal?
- Are proposed groups of buildings offering variety and texture to the townscape?
- What effect would the proposal have on the streetscape?
- Does the proposal maintain the character of dwelling clusters stemming from the main road?
- Does the proposal overlook any adjacent properties or gardens? How is this mitigated?
- Subject to topography and the clustering of existing buildings, are new buildings oriented to incorporate passive solar design principles, with, for example, one of the main glazed elevations within 30° due south, whilst also minimising overheating risk?
- Can buildings with complementary energy profiles be clustered together such that a communal low carbon energy source could be used to supply multiple buildings that might require energy at different times of day or night? This is to reduce peak loads. And/or can waste heat from one building be extracted to provide cooling to that building as well as heat to another building?

4

Gateway and access features:

- What is the arrival point, how is it designed?
- Does the proposal maintain or enhance the existing gaps between settlements?
- Does the proposal affect or change the setting of a listed building or listed landscape?
- Is the landscaping to be hard or soft?

6

Building line and boundary treatment:

- What are the characteristics of the building line?
- How has the building line been respected in the proposals?
- Has the appropriateness of the boundary treatments been considered in the context of the site?

7

Building heights and roofline:

- What are the characteristics of the roofline?
- Have the proposals paid careful attention to height, form, massing and scale?
- If a higher than average building(s) is proposed, what would be the reason for making the development higher?
- Will the roof structure be capable of supporting a photovoltaic or solar thermal array either now, or in the future?
- Will the inclusion of roof mounted renewable technologies be an issue from a visual or planning perspective? If so, can they be screened from view, being careful not to cause over shading?

8

Household extensions:

- Does the proposed design respect the character of the area and the immediate neighbourhood, and does it have an adverse impact on neighbouring properties in relation to privacy, overbearing or overshadowing impact?
- Is the roof form of the extension appropriate to the original dwelling (considering angle of pitch)?
- Do the proposed materials match those of the existing dwelling?
- In case of side extensions, does it retain important gaps within the street scene and avoid a 'terracing effect'?
- Are there any proposed dormer roof extensions set within the roof slope?
- Does the proposed extension respond to the existing pattern of window and door openings?
- Is the side extension set back from the front of the house?
- Does the extension offer the opportunity to retrofit energy efficiency measures to the existing building?
- Can any materials be re-used in situ to reduce waste and embodied carbon?

9

Building materials and surface treatment:

- What are the distinctive materials in the area?
- Do the proposed materials harmonise with the local materials?
- Does the proposal use high-quality materials?
- Have the details of the windows, doors, eaves and roof details been addressed in the context of the overall design?
- Do the new proposed materials respect or enhance the existing area or adversely change its character?
- Are recycled materials, or those with high recycled content proposed?
- Has the embodied carbon of the materials been considered and are there options which can reduce the embodied carbon of the design? For example, wood structures and concrete alternatives.
- Can the proposed materials be locally and/or responsibly sourced? E.g. FSC timber, or certified under BES 6001, ISO 14001 Environmental Management Systems?

10

Car parking:

- What parking solutions have been considered?
- Are the car spaces located and arranged in a way that is not dominant or detrimental to the sense of place?
- Has planting been considered to soften the presence of cars?
- Does the proposed car parking compromise the amenity of adjoining properties?
- Have the needs of wheelchair users been considered?
- Can electric vehicle charging points be provided?
- Can secure cycle storage be provided at an individual building level or through a central/communal facility where appropriate?
- If covered car ports or cycle storage is included, can it incorporate roof mounted photovoltaic panels or a biodiverse roof in its design?

11

Architectural details and design:

- If the proposal is within a Conservation Area, how are the characteristics reflected in the design?
- Does the proposal harmonise with the adjacent properties? This means that it follows the height massing and general proportions of adjacent buildings and how it takes cues from materials and other physical characteristics.
- Does the proposal maintain or enhance the existing landscape features?
- Has the local architectural character and precedent been demonstrated in the proposals?
- If the proposal is a contemporary design, are the details and materials of a sufficiently high enough quality and does it relate specifically to the architectural characteristics and scale of the site?
- Is it possible to incorporate passive environmental design features such as larger roof overhangs, deeper window reveals and/or external louvres/shutters to provide shading in hotter months?
- Can the building designs utilise thermal mass to minimise heat transfer and provide free cooling?
- Can any external structures such as balconies be fixed to the outside of the building, as opposed to cantilevering through the building fabric to reduce thermal bridge?



05

Delivery

5. Delivery

The design guidance and codes will be a valuable tool in securing context-driven, high-quality development in Wells-next-the-Sea. They will be used in different ways by different actors in the planning and development process, as summarised in the table.

Actors	How They Will Use the Design Guidance and codes
Applicants, developers, and landowners	As a guide to community and Local Planning Authority expectations on design, allowing a degree of certainty – they will be expected to follow the code as planning consent is sought.
Local Planning Authority	As a reference point, embedded in policy, against which to assess planning applications. The code should be discussed with applicants during any pre-application discussions.
Town Council	As a guide when commenting on planning applications, ensuring that the code is complied with.
Community organisations	As a tool to promote community-backed development and to inform comments on planning applications.
Statutory consultees	As a reference point when commenting on planning applications.

Contact
Ben Castell
Director
E: ben.castell@aecom.com